

# Section 9

Air Cleaners and Breathers... 32, 50-66

## Cables

Barnett ..... 68,70-72

Imported .....68-69

Choke cables.....48

Decals & Emblems ..... 18-19

Filters (Air) ..... 28-29,32,34, 42

Fuel Line ..... 24

Gas Caps .....14-17

Gas Tanks.....2-13

Gas Taps .....27,30-31

Gas Filters..... 26

Keihin Carbs .....45-48

Manifolds & Clamps ..... 37, 49-50, 52

Paint Saver .....3

Pingel .....31

Sportster Tanks .....12, 20-22

S&S ..... 32-41

Tank Liner .....9

Tank Mounts ..... 2,4-6,8,13,22

**Note:** If manufacturer has applied any primer finish, (it is meant only for the protection of the tanks during shipment and storage) it is **not recommended as a primer finish** for paint application without proper surface preparation. Where custom paint is to be applied, the tanks must be pressure tested, then sealed with tank prep PC #78001 and Kreem PC #78002 before painting, to help protect the final finish.

# Flatside Gas Tanks



## Flatside Fat Bob Gas Tanks 1984-E96

Reproductions of 'flatside' Fat Bob gas tanks. They fit 1984 FXST and all 1985-on models with split tanks. Mounting hardware not included but available separately. Use 1983-E96 screw in gas caps and 13/16" petcocks.

- 6037** 3.5 Gal (61218-85, 61426-85)
- 6480** 5.0 Gal (61211-84A, 61228-84)

## Rubber Mounts for Flatside Gas Tanks

These rubber mounts replace the OEM bushings parts used to mount the flatside gas tanks to FX 4 speeds 1985-86 and all Softails® 1984-on.

- 23010** 6 grommets (11447) and 2 spacers (5775)
- 16316** Spacers (5775) (10)



## Custom Hardware Kit for "Flatside" Tanks

The beveled washers and mounting screws are chrome plated, and provide a custom look. They replace the OEM screws and washers.

- 24040** All Softail® 1991-99



## FXST Lower Gas Tank Mounting Kit 1984-90

Kit for flat side tanks include chrome acorn nuts, thread stud and 2 beveled washers. Also fits 1985-86 FXWG, FXSB/EF.

- 24032**



## FXST Gas Tank Mount Kit

Includes all brackets, bolts, bushings and hardware to mount Flat Side gas tanks on 1984-up FXST-FLST models.

- 27042** 1984-90 FXST
- 27090** 1991-on FXST
- 27041** For flatsides on to 1958-84 frame (some welding required)



## Flatside Tank Mounting Kit

Mounts late model rubber mount tanks to 1958-84 FL type frames or aftermarket custom frames.

- 27041**

## Custom Mounting Kit for "Flatside" Tanks

A complete mounting kit to mount "flatside" gas tanks to custom frames (replaces the OEM parts). The beveled washers and countersunk screws are chrome-plated.

- 27040** Fits the 1984 Softail®, and all models with split tanks from 1985-on.

# Gas Tanks

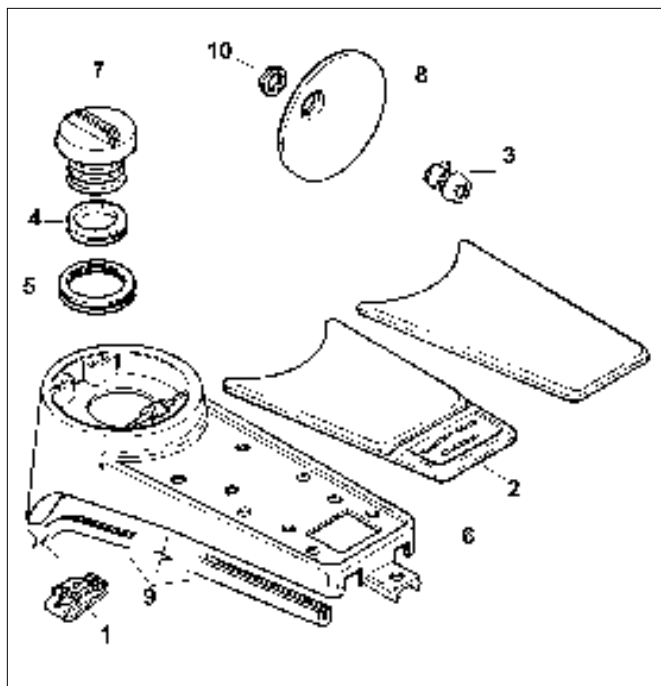

## FLT Fuel Tank Console 1988-on

#	PCP	Description
1	12626	Clip nut (7743A) (each)
2	29101	Panel insert, black (60957-89A)
	29103	Panel insert, black (60973-90)
3	62022	Universal lock, (no key) (61029-92A)
4	79435	Filler cap gasket (61109-85D) (10pk)
5	23048	Boot, filler tube (61112-82A)
6	64802	Console 1988-97 (61282-03)
	64803	Console 1998-on (61270-98)
7	29104	Filler cap, vacuum vent (61274-92)
8	29105	Console door (61278-92)
9	23047	Rubber molding (71294-89)
10	12627	Lock nut (84850-92) (5 pk)

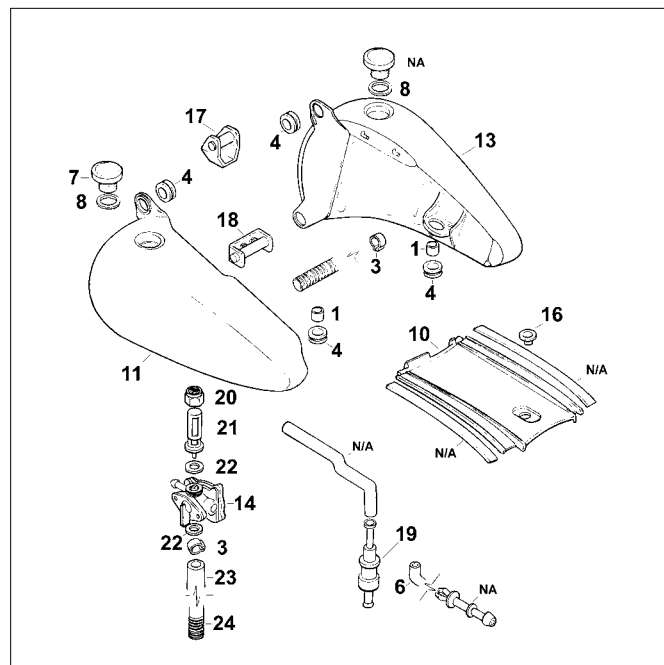

## Softail Tanks and Hardware 1992-on

All quantity each unless noted.

#	PCP	Description
1	16316	Spacer (5775) (10 pk)
3	16222	Fuel hose clamp (10014) (10 pk)
4	23010	Grommet, fuel tank mount (11447) (6 pk)
6	23050	Valve to air hose (27102-92)
7	29106	Chrome left gas cap (61103-83B)
8	25163	Gasket (61109-85D) (pr)
9	29110	Ventline connection (61131-92) (ea)
10	5452	Tank trim (61155-84B)
11	89101	Left 5 gal. fuel tank 1995-99 FLSTC/F, FXSTS/SB (61228-97)
12	29107	Chrome right gas cap (61272-92B)
13	89104	Right 5 gal. fuel tank 1992-99 FLST/F, FXSTSB, FXSTS (61291-97)
14	29403	Fuel valve 1995-* (61338-94C)
16	23501	Spacer (61641-84)
17	29111	Upper tank mounting bracket (61660-85)
18	29112	Lower tank mounting bracket (61667-90A)
19	29113	Vapor valve (62150-85)
20	12593	Chrome fuel valve nut (62161-75)
21	21611	Fuel valve strainer (62166-81A)
22	21613	Valve gasket (62172-75) (10pk)
23	29109	Preformed fuel hose (62356-95)
24	28702	Nylon wiring loom, 1/2" I.D. (63505-84) (25 ft)

# Gas Tanks

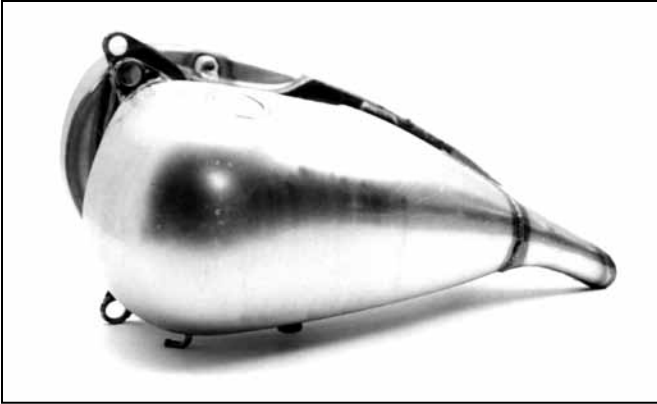

## Stretch Bob 3.5 Gal. Flatside Tanks 1984-99

These tanks feature an add-on stretch portion (non gas area) that fills the stock open area. Works with stock dash, panel, caps, 1975-on gas tap and most standard width seats.

**89008** Set

## FXST "BIG" Flatside Tanks 1984-96

These wider than stock tanks feature extra fuel capacity for longer running. Tanks are wider but, remain the same length and height to allow the use of standard dash, tank panels and seats without modifications. Flatside tanks fit all FXST 1984-96 and most aftermarket frames with Fatbob brackets. Tanks accept stock or custom 1982-on screw in gas caps and late model 13/16" petcocks.

**89025** 6.0 gallon

**89055** 7.0 gallon



## Dyna Bobbed Gas Tank 1990-95

One-piece tank comes complete with chrome dash panel and all necessary mounting hardware. Gives your Dyna a Fatbob look without all the work.

**89002**



## Frame Saver Gas Tank Mount Kit

Kit includes front and rear tank mount to mount Bobbed tanks to custom or original frames. A clamping bracket is included to allow for an easy pre-check of tank placement prior to welding the bracket in place.

**27301** 1985-99 Flat side tanks

# Gas Tanks



90062

## Bobbed Tank Kit FXR, FXD

Includes chrome cast dash assembly w. a Bob type 6 post key switch, and a plain dash base. Pre 1995 units include a 2240:1 ratio large speedo. 1995-on units include an adapter ring for the existing electronic speedo.

PCP	Application
90061	FXR 1982-94
90062	FXD 1990-94
90063	FXD 1995-05



89102

## 1996-05 One Piece 5.1 Gallon Gas Tanks

Are replacement type and accept screw in gas caps on both sides, available separately.

89102 FXDWG



## Fat Bob Gas Tank for FXR Models 1982-94

Fat Bob look for all FXR's 1982-94 (will not fit Dyna Glide™). At 4 U.S. gallons, the tank has the appearance of split tanks but is really a one-piece welded tank with 1983-on screw-top filler necks, and 1975-on 13/16" external-thread gas tap fitting. Bolts to the stock mounts and accepts FL-style dash assemblies (not Cateye) with correct dash base. All parts pictured included. The tanks are raw finished and ready for painting.

6478 Fat Bob gas tank for FXR 's



## FLT E-Z Bob Tank Kit 1980-99

Kit includes a one piece tank with bung style caps, chrome cast dash, 5 lamp dash base, 6 post bobbed style key switch, 2:1 speedo, front wheel drive cable, and hardware. This kit requires the use of solo seat or FXR style seat for installation. Allows retention of stock gauge housing and FLT key switch, if desired.

89077



## FXDWG Dash Bracket

Will accept 2000-on electronic dash and speedo and FXDWG OEM electronic dash 71246-95 and 71246-99.

73729

# Gas Tanks



## One Piece 6 Gallon Stretch Flatside Tanks

Seamless tanks are formed by a single sheet of steel drawn to create a smooth profile. These tanks do not require hours of prep work before painting and installing like a typical tank with add-on extensions. Another plus is they carry more fuel for increased riding range. May require modification of stock seat or purchase of aftermarket seat. Fits 1984-99 Softail models.

**89081** With late style screw-in caps



89094

## 2" Stretch One Piece Tanks

Fits FXD-FXDWG carb models, accepting bung caps. FXDWG style accept stock dash and speedo panel.

- 89094** Right Cap fits FXD Smooth 1991-05
- 89095** Dual Caps fits FXDWG 1991-95
- 89096** Dual Caps fits FXDWG 1996-05
- 89121** Center cap fits XL 1982-03



## Colony Tank Rubber Grommets and Spacer Kit

Kit includes 6 rubber grommets (11447) and 2 spacers (5755). Mounts gas tanks on 1984-99 Softails.  
**72105**



## Gas Tank Mounting Kit

Chrome nut, washers and studs mount gas tank on 1991-on Dyna.

- 72076** Acorn nut
- 72436** Pike nut



## Colony Chrome Gas Tank Mounting Kit

Chrome plated custom nuts, washers and stud mount gas tank.

PCP	Application	Nut
<b>72128</b>	Softail 1984-99	Acorn
<b>72438</b>	Softail 1984-99	Pike
<b>72077</b>	Softail 2000-on	Acorn
<b>72437</b>	Softail 2000-on	Pike



## Colony Chrome Gas Tank Mounting Kit

Chrome plated countersunk washers and flat head allen bolts to mount lower front gas tank.

- 72106** FLT 1998-on
- 72072** Softail 1991-99

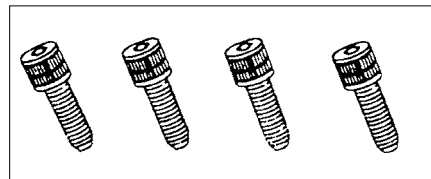

## Fuel Tank Custom Allen Mounting Kits

PCP	Description
<b>24059</b>	FXST 1984-89
<b>24060</b>	FXR 1982-on
<b>24061</b>	FXRS 1988-on
<b>24062</b>	FXST 1990-99
<b>24063</b>	Dyna 1991-on

# Gas Tank



**Stock Replacement Carb Type Tanks 2000-06**  
Accepts gas cap on right side and fuel gauge on left.  
**89103**



**89097**



**89098**



**89092**

## 5 Gallon Extended Gas Tank

For FLT models including FLHT, FLHR and FLTR. Tanks include custom console to cover OEM gauge sending unit. Use standard bung right and left caps and petcock. Shorter seat may be required.

**89092** 1997-03

**89093** 1989-96



**89099**



## Stretched Tank

Features flat bottom for universal mounting on extended neck frames.

**89087**



## Smooth One-Piece Tanks

Fits 1984-99 FXST models are 4.2 gallon, stretch and includes hardware for mounting. Order stock bung caps separately. Some seats may not match up. #89099 is a 2" stretch, 1 piece tank with a 2" extension weld on.

**89097** Is a 2" stretch, single cap

**89098** Is a 2" stretch, dual cap

**89099** Is a 4" stretch, single cap

# Gas Tanks



**89083**



**89082**



**89084**

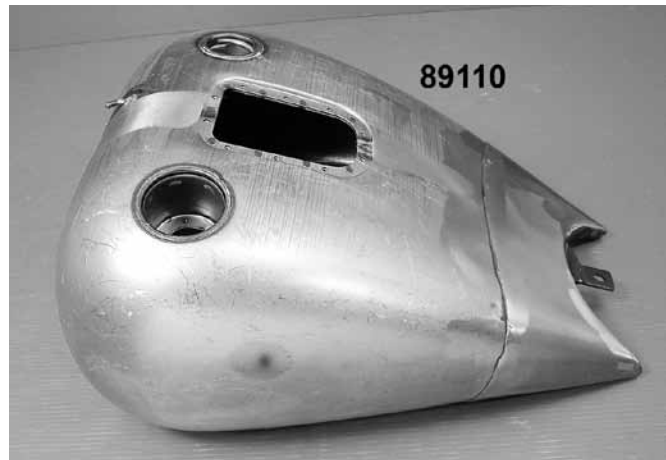

**89110**

## 2004-on One Piece Gas Tanks

Fits FXST models. 5.1 gallon tanks use stock mount hardware and accept right and left threaded bung cap sets. (Stretch tanks have a 2" extension with a welded seam)

PCP	Type	Model	Year
89082	Stock	Carb	2004-07
89083	Stretch	Carb	2004-07
89084	Stock	EFI	2004-07
89100	Stretch	EFI	2004-07
89109	Stock	EFI	2008-on
89110	Stretch	EFI	2008-on



## 2000-on FXST Tank Mount Kit

Includes all hardware bushings and front bolt with chrome cap nuts.  
**24105**

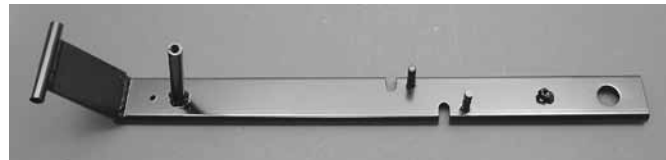

## FXST Tank Mount Adaptor Kit 2000-on

Allows the use of 1984-99 2 piece Bob tanks with their original dash panel on 2000-on FXST models.  
**27617**

# Flush Cap Tanks



89037



89038



89044

## Flush Mount Cap Custom Gas Tanks from Custom Chrome

These tanks feature locking flush mount gas caps. They are low temperatures welded at welding joints. Locking gas caps and 2 keys included.

### Big Twins

**89038** 6 Gal., FXST 1984-99

**89037** 4 Gal., 1 piece with dash mounts all FXR 1982-94

### Sportsters

**89042** 3.25 Gal. King tank 1982-94

**89043** 3.25 Gal. King tank 1995-on

**89044** 3.2 Gal. Bob tank with dash mounts 1982-94

**89045** 3.2 Gal. Bob tank no mounts 1982-94

### Replacement Parts

**16259** Set of keys (pair)

### Kreem Tank Degreaser

Perfect for use on new aftermarket tanks. This safe, biodegradable degreaser quickly removes protective oily coating from inside new tanks. Used prior to the Kreem Prep kit this material ensures a clean, oil free surface. It can also be used as a general purpose cleaner/degreaser.

**78004** 1 pint bottle (each)



78001

78002

78003

### Kreem Tank Mask

This water based liquid mask is easily applied to painted tanks and other painted surfaces. It dries to a non tacky film that resists Kreem fuel tank liner and prep B materials. For use on tanks with expensive outsides that need Kreem liner on the inside. Just paint it on, let it dry, prep and coat the inside, then peel or wash the Kreem tank mask away using warm soapy water.

**78006** Each



### Kreem® Gas Tank Prep Kit and Gas Tank Liner

A two-stage kit that prepares a gas tank for sealing. Tank Prep A is a concentrated cleaner, Prep B a final rinse and conditioner. The Kit removes loose rust and dirt inside the tank while at the same time conditioning the inside of the tank leave in. The kit includes 1 pint of Prep A and 1/2 pint of Prep B. The tank liner produces a "tank within a tank". The liquid quickly cures to a tough, elastomer compound that seals and protects any tank, while preventing rust and leaks. It resists alcohol and gas and withstands most octane boosters. Tanks require one pint of Kreem® per three gallons of tank capacity.

**78001** Kreem® gas tank prep kit (2 bottles as pictured)

**78002** Kreem® Gas tank liner

**78003** Kit of 3 bottles (1 each of cleaner, conditioner and sealer)

# Stretch Gas Tanks



89047



89058

## BT Stretch Flatside Gas Tanks 1984-99

These tanks feature an additional stretch that completely fills the space between the tank and seat. Each tank is constructed from heavy gauge steel for use with stock dash, tank panel, late model (13/16" thread) petcock and most standard width seats. Available for standard 1983-on screw in gas caps or for aircraft style (flush mount) screw in gas caps. Stretch portions do not hold fuel and some wide or touring seats will require modification. (Purchase caps separately)

### For Screw-in Caps

- 89008 3.5 gallon
- 89034 4.2 gallon
- 89047 5.0 gallon
- 89036 5.2 gallon
- 89029 6.0 gallon
- 89050 7.0 gallon

### For Flush Mount Aircraft Screw in Gas Caps

- 89058 7.0 gallon
- 21650 Cap set



## Big Twin Stretch Flatside Gas Tanks 1984-99

Tanks feature stylish extensions that asthetically enhance the form of your bike. Tanks are available with fitting for the new "Aircraft" style, gas caps. Please note: the extensions do not hold fuel and it may be necessary for proper fit to modify wide or touring seats.

- 89030 Aircraft style gas caps, 6 gallon



## Custom Flush Mount Gas Caps

Aluminum, flush mount gas caps customize BT or XL models. Bolt-in type with standard or locking cap. Installation requires modification to the tank filler neck.

- 21650 Set without lock, includes vented and non-vented
- 21651 As above with lock
- 21652 Vented gas cap with outer ring (without lock)
- 21653 Vented gas cap with outer ring (with lock)

### Gas Caps Only

- 21654 Vented and Non-vented (no locks) (pair)
- 21656 Vented cap only (no lock) (each)
- 21647 Vented cap only w/lock (each)
- 21645 Non vented gas cap only without lock (each)
- 21646 Non vented gas cap only with lock (each)



## BT Aircraft Flatside Gas Tanks 1984-99

Designed to accept aircraft style flush mount gas caps and mounting rings (sold separately). The aircraft caps are designed to mount to a special recessed area that keeps the top of the cap flush with the tank surface. Tanks are designed to work with most frames with flatside brackets and large diameter speedometers, dashes, trim panels, and 13/16" threaded petcock. Fits FXST 1984-on and most aftermarket frames with Fatbob brackets.

- 89028 5.0 gallon
- 89052 6.0 gallon
- 89053 7.0 gallon

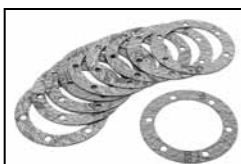

### Replacement Parts

- 25284 Mounting ring gasket (10 pk)
- 24554 Mounting ring chrome screws (12 pk)

# Gas Tank



## 2" Extended Tanks 2000-on FXST (5 Gal.)

PCP	Model	Bung
89139	Carb	Single
89141	EFI	Right and left

89142 EFI Right bung, left gauge 2000-05

Note: 2004-on Carb models use EFI tanks

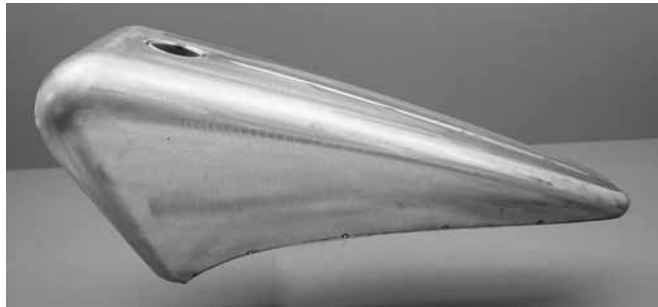

## Wyatt's Curved Fuel Tank

Features radius under side. (24" OAL, tunnel length 19" x 2")  
89125



## Weld-In Petcock Inserts

PCP	Type	Thread
73725	Male	1975-on
73726	Female	3/8 NPT

## Mini Screw-In Gas Cap

Includes weld-in bung.  
73730



## FXST Stretched Tanks 2000-on (5 Gal.)

Will accept left side fuel gauge.

89123 Carb 2000-03

89124 EFI 2000-06 and carb 2004-05



## Flush Tank Mount Kit

Can be welded to flat bottom tank for a clean look.  
73724

# Gas Tank



## XLS 2" Stretched Tank

One piece stretched tank features curved design with full rubber mounting. For 1995-on models a coil and switch location kit must be ordered separately. PCP# 89111 is a 1982-03 dash type that accepts 2, 3 or cast dash assemblies.

PCP	Type	Years
89111	Dash	1982-03
89121	Single cap	1982-03
89137	Single cap	2004-on



## 3.5 Gallon Replica Style Tank 1982-03

PCP	Year	Petcock
89114	1982-03	Left
73607	Cap	



## Replica Captain America Gas Tank

Features 2.2 gallon capacity with two 1/4" petcock outlets, straight mount tabs front and rear, and centre fill gas cap location.

89112



## Mustang Style Tank

Features single chrome pop-up cap installed.

89144 3.3 Gallon



## Radii Tear Drop Tank

Features curved underside with recessed mount holes.

89126 27" Long

# Gas Tank

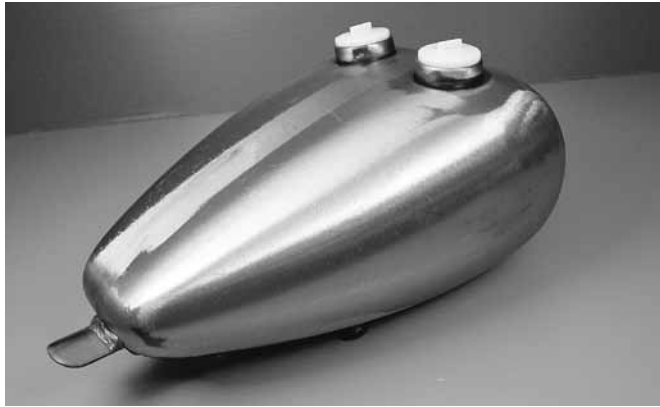

## 3.3 Gallon Axed Cap

Features dual cap design and universal mount tabs.

- 89088** Right side petcock, Dual cap
- 89089** Left side petcock, Dual cap
- 89090** Left side petcock, Single cap
- 932** Gas cap, vented (each)

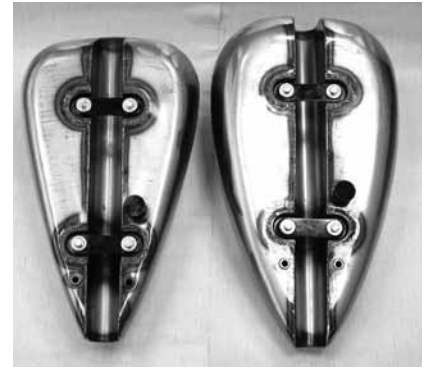

## Wyatt Gatling Image Tanks

Pop up tanks include cap.

- | PCP          | Stretch | Cap Type                                 |
|--------------|---------|--|
| <b>89118</b> | 4"      | Pop-up (23" OAL, tunnel 19" x 1 7/8" ID) |
| <b>89120</b> | 4"      | Screw                                    |



## 2.2 Gallon Koffin Tank

Fits 1-1/2" top frame tubes and accepts 1/4" petcocks. Measures 17-1/2"L x 9"W. Raw finish. Has single front tab and rear U bracket for mounting.

- 89079** Tank
- 3085** Cap



## 2000-on FXST Tank Mount Kit

Includes all hardware bushings and front bolt with chrome cap nuts.

**24105**

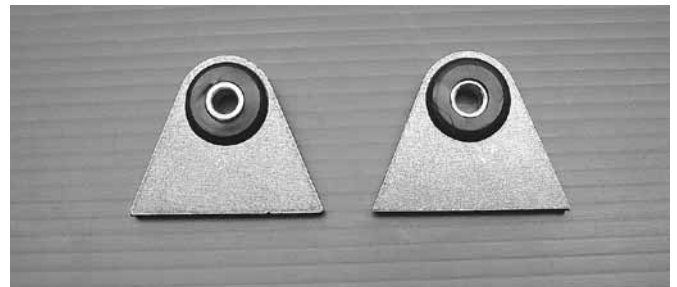

## Weld-On Bracket Set

Includes bushings and steel sleeves.

**73727**

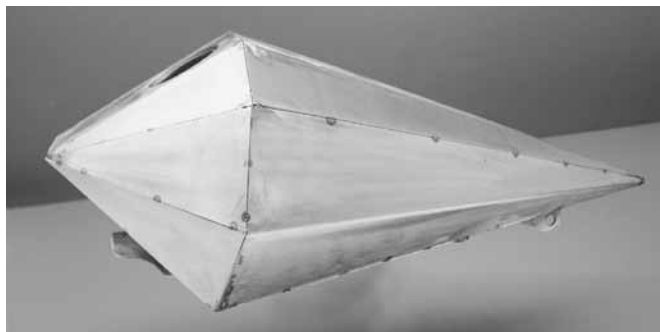

## 2.2 Gallon Wyatt Pirate Gas Tank

Small size allows for full engine view. Measures 22" long with a 19.5" tunnel length.

**89091**



## Iso Mount Strap Set

Fits bottom of tanks using 3 5/8" C/C holes.

**73728**

# Gas Caps



## Chromed Steel Late Threaded Gas Caps

These beautifully plated late styled "bung" steel caps are quality replacements of the OEM part. These caps come with the latest low-pressure relief vent correctly recessed in the cap to clear the filler neck vent tube on 1983-05 gas tanks.

PCP	Description
3083	Set, left and right hand thread
3084	L/S cap only 1983-95 (non-vented) (61103-83)
3085	R/S cap only 1983-95 (vented). Also fits single cap models except FLT(C)/FLHT(C) (61102-83A)
45480	R/S cap (vented), (61272-92A) 1996-05
45481	Set, left and right (61103-83B,61272-92A) 1996-05



## Chrome Plastic Threaded Gas Caps 1983-95

A set of plastic bodied, nylon thread, screw-type gas caps for OEM as well as PCP tanks with screw-type filler necks. Available for split tank models 1982-on, with correct pressure relief setting and ratchet "overrun" design. Right side cap is available individually for single tank models including XLX, XLH, XR (but not FLT and FLHT) 1982-on, and most XLS models and all FXR series models 1982-on.

PCP	Description
3086	Set, left and right hand thread 1983-95
3087	R/S cap only for single tank models only (61102-83A) vented 1983-95
3088	L/S cap only 1983-95 (non-vented) (61103-83)



3285



3288

## New Style Ratcheting Gas Cap (Stainless)

Gas cap for all 1983-95 Big Twins.

PCP	Description
3285	With vent 1983-95 (61102-83A)
3288	Without vent 1983-95 (61103-83)



## Chrome Locking Gas Caps

These caps fit 1983-95 models with Bung type filler cap. Includes 2 keys.

45441	Set
45442	Vented cap only



## 'Eagle Spirit' Threaded Gas Caps

These plated late-style steel caps are perfect mechanical reproductions of the OEM part. They come with the latest low-pressure relief vent properly recessed in the cap to clear the filler neck vent tube on 1985-05 gas tanks.

Chromes	Gold Overlay	Description
45135	45235	Matched set 1983-95
45137	45236	Vented, right 1983-95
	45237	Non-vented, Left 1983-95
	45377	Complete set 1996-05



449



450

## Custom Gas Cap Covers

Fits 1973-on. Sold each.

450	Satellite
449	Krommet

## Gas Cap Identification

1983-95 approximately 1.750 O.D. of thread  
1996-05 approximately 1.800 O.D. of thread

# Gas Caps



## Gas Tank Fuel Gauge

PCP	Application
29426	1988-94 FXRS, 1991-00 FXDL, 1995-00 FLHR, 1995-00 FXDWG, 2000 all FXST (75049-88B)
29427	1994-2000 FXD (75067-94A)
29428	2001-on FXD, FXST, FLST, FLHR (75049-01A)



45476

## Low Profile Cap Set

Caps feature a polished mirror stainless finish. For use with Bob tanks 1984-on.

PCP	Application
45448	1983-95 Cap set
45476	1996-05 Cap set
45477	1983-95 Vented cap
45478	1996-05 Vented cap

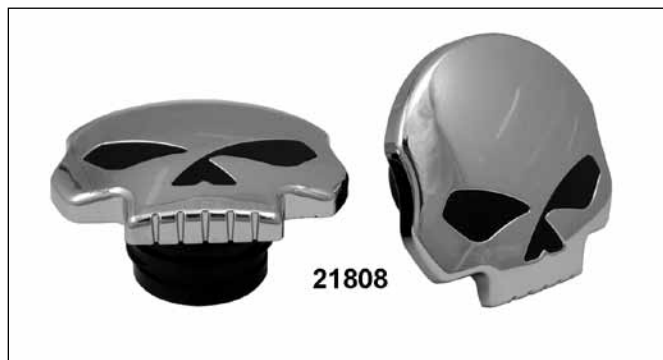

21808

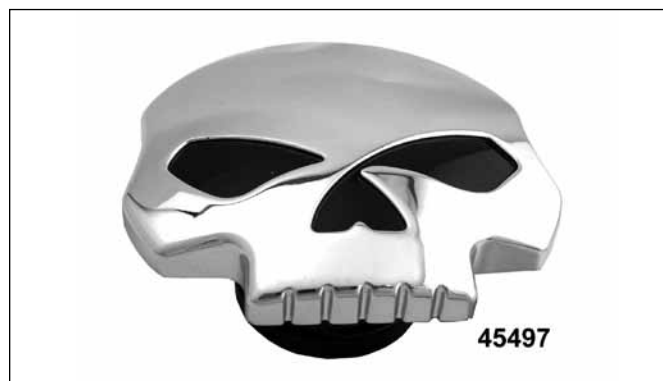

45497

## Chrome Skull Gas Caps

PCP	Type (XL-FXD 1992-on)
45497	Vented (75097-05)
45498	Non-vented
21808	1996-05 Set (L&R)
21810	R&L Dummy cap



45352

## Chrome Cap Kit

Features a uniquely designed insert which is permanently installed in the existing bung on bobbed tank sets for 1984-on BT models. Inserts will prevent flaking around the filler neck or conceal existing damage to finish in this area. The chrome caps thread into this insert and act as the actual gas cap. Sold in pairs.

PCP	Application
45352	1996-05
45378	1984-95
26162	Wrench



45352



## Chrome Pop-up Cap Set

Fits right and left side on 1983-05 tank sets by pushing in centre cap, the knurled portion appears and allows turning of the cap.

45479	Set 1983-95
45449	Vented cap only 1996-05

## Gas Cap Identification

1983-95 approximately 1.750 O.D. of thread  
1996-05 approximately 1.800 O.D. of thread

# Gas Caps



## Low Profile Cap Set

Polished stainless steel cap has a peaked center.

### PCP Application

- 59800** 1983-95
- 59815** 1996-05



59801

## Lone Star Low Profile Cap Set

Pointed style cap features a star motif and is sold as a set or individual vented cap. Fits all 1983-on models.

### PCP Application

- 59801** 1983-95 set
- 59802** 1996-05 set
- 59803** 1983-95 vented cap only
- 59804** 1996-05 vented cap only



## Iron Cross Billet Gas Caps

### PCP Application

- 59807** 1983-95 (pair)
- 59808** 1983-95 vented cap only
- 59880** 1996-05 (pair)



## Billet Flame Cap Set

Fits 1984-99 with vented right cap and non-vented left threads. 1996-on with left side dummy cap to replace fuel gauge.

- 59806** 1984-95 Set
- 59882** 1996-05 Set
- 59883** 1983-05 Vented cap (each)



59915

## Smooth Pop Style Cap Sets by Wyatt Gatling

PCP# 59915 is set with left side dummy.

### PCP Application

- 59912** 1982-95 Set
- 59913** 1982-95 Vented
- 59914** 1996-05 Vented
- 59915** 1996-05 Set



## T/L Gas Cap Medallion w/Adhesive Backing

Fits most 1983-on models (except 2005-06 FXDC, 2004-on XL Custom and FXD, FXDX; FXR with plastic fuel cap, Electra Glide, Tour Glide, Road Glide, VRSC and gas caps with fuel gauges.

- 63022** 99537-96 (each)



59308

59308

## Chrome Pop-Up Cap Sets

Features built-in dress ring with o-ring for seal at cap area.

### PCP Application

- 59308** 1983-95 Left, non-vented
- 59309** 1983-95 Right, vented

## Gas Cap Identification

- 1983-95 approximately 1.750 O.D. of thread
- 1996-05 approximately 1.800 O.D. of thread

# Gas Caps



## Chrome Billet Cross Gas Cap

Features cross design. #45492 Set includes right side vented cap and left side dummy cap to replace the fuel gauge.

### PCP Application

- 45490** 1992-on XL-FXD (not 2004-on FXD/X, 2005-06 FXDC and 2007-on FXDSE) & Softail 2000-on (ea)
- 45491** 1983-99 Set
- 45492** 1996-05 FXST-FXDWG with fuel gauge (set)



## T/L Billet Fuel Caps

Machined and chromed billet fuel caps feature a decorative design and an interesting shape. These caps fit on 1992-on XL and Dyna (not 2004-on FXD/X, 2005-06 FXDC and 2007-on FXDSE) 1994-on Road King and 2000-on Softails.

### PCP Design

- 63031** Cross (62816-03)



## Chrome Pop-up Flush Mount Cap

Includes vented cap and weld-in steel insert.  
**45493**



## Chrome Billet Cap Set

Are constructed from solid bar and machined for 1983-95 right and left sides.

- 45485** Low style
- 45486** Medium style
- 45487** Tall style



## Chrome Cap Set 1996-05

Features screw-in right side with left side dummy to replace fuel gauge.

- PCP Style**
- 59515** Low-profile
- 59517** Chrome LTR



## XL Bung Style Gas Caps 1983-95

Vented caps for single cap tanks. Sold each.

- PCP Style**
- 45449** Pop-up
- 59883** Flame
- 59808** Maltese
- 21644** Profile
- 45236** Eagle Spirit with gold inlay

## Gas Cap Identification

- 1983-95 approximately 1.750 O.D. of thread
- 1996-05 approximately 1.800 O.D. of thread

# Decals

We offer no warranty, nor do we recommend any clear coating to be applied over our decals or tank transfers.

#	PCP	OEM	Description
2	22106	14171-87	Brandy wine, gold, black 2 3/4" x 8 1/4"
3	22108	14031-87	Silver, blue 3 1/2" x 10 1/2"
	22110	14165-87	Brandy wine, gold, orange
4	22107	14172-87	Root beer, gold, black
	22125	14007-82	Gold, red 2" x 6"
5	22111	14001-82	Gold 1 7/8" x 7"
	22112	14002-82	Gold, red
6	22114	14143-86	Silver, red 1 3/4" x 10 1/2"
8	22117	14005-82	Gold, black 2 3/4" x 3 1/2"
10	22119	14228-89	Silver, grey, orange 3 1/4" x 8 1/2"
11	22120	14323-90	Red 3" x 9"
		14325-90	
14	22148	61255-82	Black, white 1 3/4" x 6 1/4"

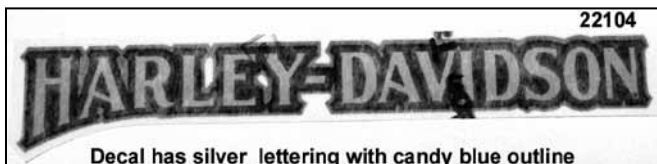
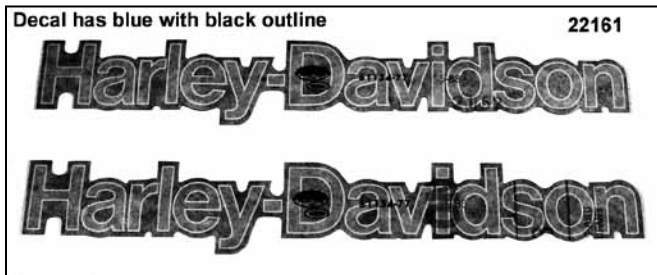
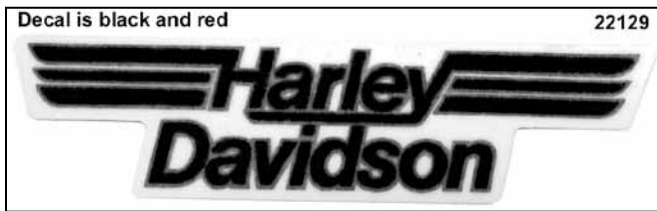

## Topline Decals

PCP	Description
22126	Red, grey, gold, dark grey (14363-92) (each)
22129	Red and black (61908-81A) (each)
22104	Light blue, dark blue, silver (14318-90) (each)
22105	As above, red, dark red, black, gold (14317-90) (ea)
22161	Blue with black outline (61134-77) (pair)



## Retro 1959-1960 Style BT Emblems

Exact reproduction of the tank emblems used on Big Twins 1959 & 1960. Chrome plated with red background. Sold in pairs. For custom applications use the adhesive mounting plates, sold separately.

PCP	Description
66220	Pair of emblems (61775-59T)
27059	Pair of adhesive mounts (61742-93T)



## Big Twin 1951-54, 52-54 K-Model Style Emblems

Custom application requires adhesive mount plates, sold separately.

29610	All chrome (61774-51T)
27057	Mounting plates (adhesive) (61784-92T)



1



2



10



11

#	PCP	OEM	Description
1	22133	14261-91	Silver, red orange, black
	22139	14262-91	Silver, meteor, grey, black
2	22135	14289-94	Gold, black
10	22171	14550-96	Pale gold, red, burgandy
11	22172	14524-96	Burgandy, red
	22173	14525-96	Dark blue, sky blue



### Big Twin 1963-65 & XL' (61777-63T)

Custom application requires adhesive mount plates, sold separately.

29608 White & black with chrome letters 6-11/16" C/C

27054 Mounting plates (adhesive) (61782-91T)



### Big Twin 1961-62 (61776-61)

Custom application requires adhesive mount plates, sold separately.

29603 Chrome, white with black letters 5-3/8" C/C

27050 Mounting plates (adhesive) (61740-90T)



29617



29615



29614



29613

### Tank Medallion Sets

Sold as right and left set.

PCP OEM

29613 61830-06, 61831-06

29614 62093-04, 62094-04

29615 62097-98, 62098-98

29617 62288-05, 62289-05

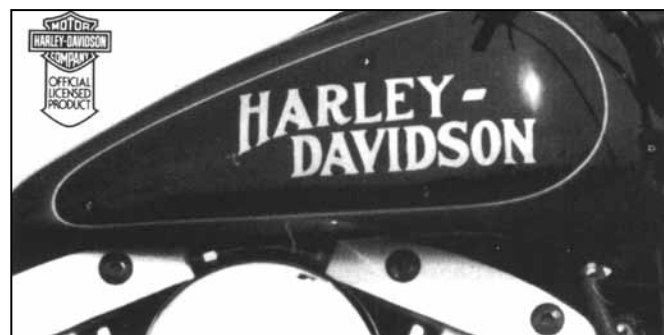

### FXS Stock Style Tank Decals

Pressure sensitive die cut decals measure 3" wide by 8 1/4" long. Stick-on type, sold in pairs.

PCP Description

1239 Red with black border (61205-77)

1242 Black with white border (61236-78)



22141

### Topline 883 Decals

PCP Description (Each)

22141 Silver, blue (14232-90)

22142 Black, red, orange (14233-90)

22143 Light blue, dark blue, silver (14232-91)

22144 Red, gold, yellow (14233-91)

22145 Black, red, gold, orange (14343-92)

# Sportster® Tanks



## 3.2 Gallon XL One Piece Bobs

Tanks fit XL models. Bolts to existing holes. Accepts 2 or 3 light dash kits which must be ordered separately. Must use XLS or shorter seat on 1982-on models. Order caps and dash separately.

PCP	Description
89071	1982-94
89127	2004-on
27259	Iso Mount kit 1982-03



## XL 3.2 Gallon Quick Bob Tanks

Feature a smooth top that **does not** accept dash panel or speedo. Includes one piece tank and mounting hardware.

PCP	Description
89004	1982-94 use 83-on screw style caps
89005	1995-03 use 83-on screw style caps (left side tap)



## XL Bobbed Gas Tank Kits-----Solid Mounted

Kit includes all parts necessary for a solid mount version. The dash panel accepts FL speedometer but does not accept the stock FL key switch, (plain dash only). Order speedo separately. All kits can be used with a solo seat (or custom seat with a shorter nose like the XLS type). Dash does not accept a speedo with a built in tach.

89017	1982-94
89059	1995-03

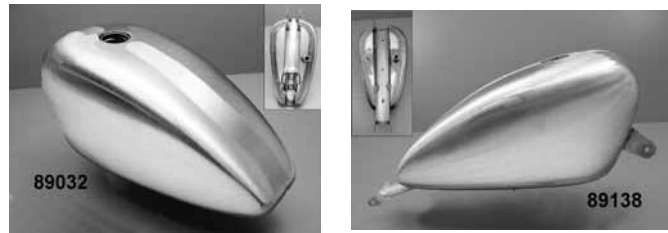
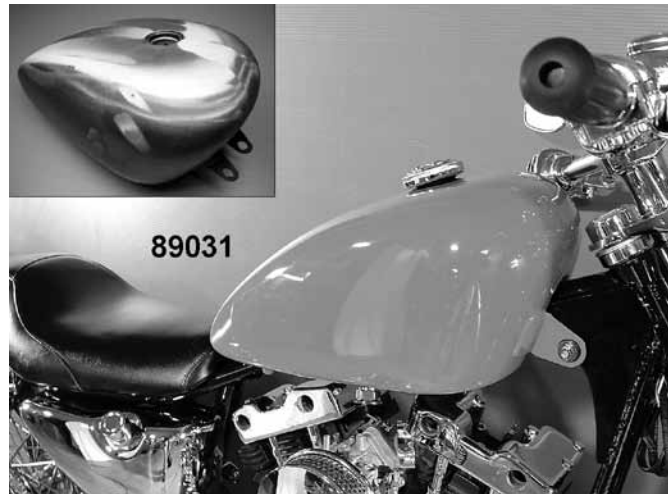

## 3.2 Gallon XL King Tank

Classic shaped custom tank design features rolled under bottom edge that provides a flowing line to the look of your bike. Tanks are replicas of the 1996-on OEM style tank that are stock on 1997-03 XL. Measure 20" long by 10" wide.

PCP	Years	Tap Side
89031	1982-94	Right
89032	1995-03	Left
89138	2004-on	Left (62213-04)

**Note:** The zinc-chrome primer is for the protection of the tanks during shipment and not recommended as a base coat for paint application. As with any fuel tank, particularly one where custom paint is to be applied, the tanks must be pressure tested, and temporarily mounted to frame to check clearances, then sealed with tank prep (PC #78002) before painting.

**Note:** When installing on 1992 to 1994 models and disconnecting or eliminating the OEM continuous venting system, you must replace the stock vented cap with an earlier version screw cap.

# Sportster® Tanks



## “Standard” Gas Tank for Sportster

OEM-styled Sportster High-Tunnel Tank features stock mounts. 2.4 U.S. gal. capacity. Uses 1975-on style gas tap.

### PCP Fits

**6034** 1982-92 (61023-83)

**89035\*** 1993-03 (61264-93)

\*Uses late type screw-in cap



## “King” Gas Tanks for Sportster

King tanks are made 2" wider than stock, to give you that needed extra mileage. 3.1 U.S. gal. capacity.(stock 2.2 U.S.) Measure 2" wider than stock and is 17-1/2" long by 10-3/4" wide. Accepts 3/8" NPT petcock PCP# 938 and a screw cap. 1982-on tanks are fitted with correct internal venting system.

### PCP Years Tap Side

**6273** 1982-92 Right

**89020** 1993-94 Right

**89140** 1982-94 Left



## Paughco Porkster Tank for Sportster Models

This 4.1 U.S. gallon axed style large tank bolts on to Sportster models 1952-on. Dual tank left cap is non-functional. Use #932 vented gas cap and stock gas taps. All tanks come with base metal raw finish.

### Single Cap Dual Cap Fits Tap Side

**89012** **89014** 1982-94 Right

**89018** **89019** 1995-03 Left

**89131** **89132** 2004-on Left

### Rubber Mounted Style

**89133** **89135** 1982-94 Left

**89134** **89136** 1995-03 Left



## Fat Bob Tank With Dash Kit

Kits fit Sportster models and feature rubber mounted one piece tank with 3 Light dash kit consisting of: mount plate, 2:1 ratio Bob speedo, 42" cable for front wheel drive, and late Bob key switch. Kit also includes chrome caps and all hardware necessary for installation.

### PCP Description

**89023** 3.2 Gallon XL 1982-94

**89065** 3.2 Gallon XL 1995-98 adaptor for digital

**89024** 4.0 Gallon FXR 1982-94

**IMPORTANT:** To eliminate any potential problems with your gas tank we recommend that you pressure test, seal and mount your tank before painting.

# Sportster® Tanks



## 3.2 Gallon E-Z Bob Tank Kit XL 1982-98

Tanks feature one piece design, chrome bung style late caps, chrome cast dash kit and installation hardware.

- 89073** 1982-94
- 89074** 1995-03 No speedo
- 89145** 2004-on



## 3.2 Gal. XL Quick Bob Tanks 2004-on

**PCP Application**  
**89129** Smooth



## Chrome Sport Bob Tank Mount Kit

Kit allows you to mount Sport Bob tanks on Sportster models. Kit includes switch cover, horn relocation bracket, choke bracket, coil bracket and hardware.

**73514** For use with PCP tank #89071 and #89004



## Colony Chrome Gas Tank Mounting Kit

Chrome plated custom acorn nuts, washers, studs, spacers and grommets to mount gas tank on Sportster 1996-on models.

- 72107** 1996-03
- 72265** 2004-on

## Iso-Mount Kit

For XL Bob tank kits.

- 27259** 1982-03
- 73514** 1995-on Coil mount kit



## Gas Tank Mount Kit

Fits 1995 model tank, PCP #89071.

**27153**



## Braided Steel Crossover Lines

Lines include chrome ends, seals and a protective clear plastic tube.

- PCP Application**
- 77625** 1993-05 FXD
- 77627** 2000-05 FXST
- 77626** 1986-99 FXST

# Gas Tank Related



**T/L Fuel Tank Sending Unit FLT 1988-95**  
**29129** 75040-88A



## T/L Fuel Tank Sender Units-USA

PCP	Application
29127	FXR 1988-94 (75057-88)
29128	FLT 1984-87 (75037-84)
29129	FLT 1988-95 (75040-88A)
29130	FLHT, FLHTC 1996 (75040-96)
29131	FLT, FLHT 1997-on (75040-97B)
29132	FLT w/fuel injection 1995-on (75071-95)
29133	FXD 1990-94, FLHR 1995, FXDL, FXDWG 1990-on, FXST 2000-on (75062-90A)
29135	FXD 1997-on (75078-97)
29136	FLHR 1996-on (75064-96)



## T/L Standard Fuel Injector

For EFI FLT models 1997-01.  
**29124** 27135-97



## T/L Standard Air Temperature Sensor

For EFI FLT models 1995-00.  
**29126** 27270-95

## T/L Fuel Pressure Regulator EFI 1995-00

**29125** 27219-95A



## Russell Fuel Crossover Lines

These stainless braided hoses have chrome ends that utilize chrome compression fittings in place of the normal hose clamps. Maximum fuel flow is achieved with an ID of 5/16". 1986-99 Softail model lines are also available with a quick-disconnect fitting which allows the tanks to be removed without having to drain them first.

### PCP Application

<b>77623</b>	1991-05 Dyna
<b>77624</b>	1986-99 Softail
<b>77628</b>	2000-05 Softail (not for Duece)

## Fuel Injection Replacement Parts 1995-on EFI

PCP	Application
29175	Fuel injector (27218-95)
29125	Fuel pressure regulator 300 K PA (27219-95)
29176	Fuel pressure regulator 350 K PA
29177	Fuel injector (27609-01)
29178	High flow fuel injector
29179	Barometric sensor 100 K PA (32424-95)
29180	Barometric sensor 250 K PA
29181	Idle air control motor (27628-01)
29182	Idle air control (27658-06)
29126	Air temperature sensor (27270-95)
29183	Engine temperature sensor (32446-99)
29184	Throttle position sensor (27629-01)
29185	Throttle position sensor (27659-06)
29124	Fuel injector (27135-97)
29186	Relay with diode (31511-01A)
29187	Map sensor (32316-99)
29188	Coolant temperature sensor (32315-01)
29190	Gasket and seal kit
29193	Oxygen sensor (27683-06)
29194	Oxygen sensor plug (66054-06)

# Fuel Line



## Braided Gas Line Kit

Includes 2 feet of 5/16" braided covered line and 4 econo-seal chrome end clamps.

**77425** Kit

## Reinforced Fuel Line

Heavy duty reinforced gas and oil line. 1/8" wall. Sold in 25-foot rolls.

PCP	I.D.
<b>3048</b>	1/4"
<b>3052</b>	5/16"
<b>3054</b>	3/8"



## S.S. Mini Hose Clamp

Screw type steel clamp.

PCP	O.D.
<b>3846</b>	3/8"-5/8" (10 pack)
<b>3850</b>	1/2"-3/4" (10 pack)



**3055**



**77436**

## Reinforced Black Fuel and Oil Line (25 Feet)

Neoprene fuel and oil line for all Harley models. Available in shop supply 25-foot rolls, this top quality line is reinforced with high strength rayon. Neoprene outer cover resists oil and grease for years.

<b>77436</b>	1/8" (10 foot roll)
<b>77437</b>	3/16"
<b>3055</b>	1/4"
<b>3056</b>	5/16"
<b>3057</b>	3/8"



## 5/16 Stainless Steel Gas Line

**77433** Sold in 5 foot lengths

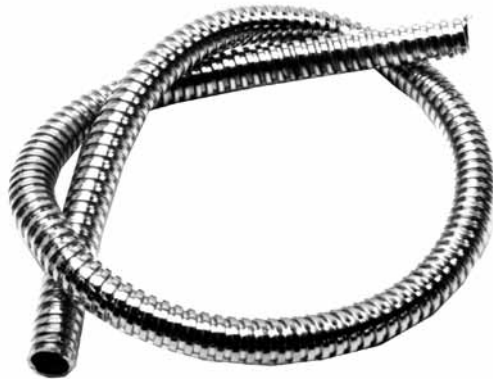

## Chrome Metal Hose Cover

Flexible spring loaded covering in 3 foot lengths. To install, cut to same length as hose, hose cover will compress under tension to allow installation of hose clamps for a snug fit. Protects from heat and abrasion.

<b>77427</b>	1/4" Fuel line cover
<b>77429</b>	3/8" Oil line cover



## Econo-Seal Hose Ends

The ultimate hose clamp. Perfect for all gas and oil lines. Provides additional support. May be used over again. When used with our custom steel braided line they present a custom look. Chrome. 5/16" ends fit 1/4" hose. 3/8" ends fit 5/16" and 3/8" hose.

<b>875</b>	1/4"-5/16" chrome (6 pack)
<b>868</b>	5/16"-3/8" chrome (6 pack)

# Tank Hardware



## Flex Chrome Hose Covering

Features heavy gauge mylar construction with chrome finish.

**PCP** 25' Length

**77459** 1/4"

**77460** 3/8"

**77461** 1/2"



## Gas Cap Gaskets

Replacement rubber gaskets for aftermarket and OEM tanks. Sold in 10 packs for all 3.5 and 5 gallon tanks.

**PCP** Description

**25163** 1982-on (61109-85C) (pair)

**79435** As above, James (61109-85C) (10 pack)



## Chrome XL Enricher Knob Bracket 2004

This polished and chrome plated bracket includes chrome hardware to mount on 2004 XL 883, 883C and 1200R models.

**61209** T/L 16358-04

**27384** Preston as above



## High Flow Fuel Inlet

Replaces broken fuel inlet to the carburetor bowl for modified motors. Fits all Keihin carburetors (Butterfly and CV) 1976-on BT Evo, TC and XL.

**44049**

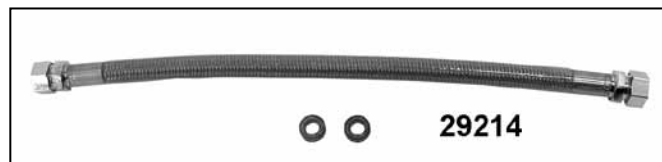

## T/L Braided Stainless Steel Fuel Crossover Line

Braided stainless steel crossover line has polished chrome fittings that eliminate the need for hose clamps.

**PCP** Application

**29216** 2000-on Softail except FXSTD and FXCW/C (63692-00A)

**29215** 2000-on FXSTD models (63694-00A)

**29214** 1986-99 Softail models (63696-00A)



## T/L Braided EFI Fuel Line Dyna 2004-05

Braided stainless steel line includes fuel tank and EFI module connectors for easy installation on 2004 Dyna models with fuel injection.

**62352** 63020-04



## T/L Fuel Fitting Covers 2000-03 FI

Chromed billet aluminum cover features a milled emblem and mounting hardware. Cover is contoured to hide fuel tank fittings on fuel injected models.

**61219** 2000-01 Touring & 2002-03 Softails (62883-02)

**63015** 2002 Touring (62884-02)

# Gas Line Filters



## Russell Street Fuel Filter

This chromed billet aluminum bi-directional filter is vibration, heat and shock resistant. This easy to install, compact filter features a replaceable 40 micron bronze element that traps tiny particles preventing damage. Can be used with pump gas but is not compatible with alcohol.

- 77692** 1/4" line
- 77693** 5/16" line
- 77695** Replacement element for all Street filters



## Mini Gas Filters

These clear mini Gas Filters completely come apart so that dirt trapped in filter may be discarded. The design of this filter helps to prevent water and other agents from passing to the carburetor. The ends are chromed.

- 942** 1/4"
- 943** 5/16"



## Chrome High Performance Gas Filters

Alloy case fuel filter with replaceable bronze filter element. Available in 2 fuel sizes. Outstanding filtration.

- | PCP          | Size  |
|--------------|-------|
| <b>77044</b> | 1/4"  |
| <b>77045</b> | 5/16" |



## Chrome Billet Filter

Radius style fits 5/16" hose with replaceable filter.

**77047**



## Chrome Billet Fuel Filter

Features high flow design for 5/16" line

**77048**



## Sifton Chrome Compact Fuel Filter

Machined aluminum unit features a stainless steel filter that is washable and reusable. These filters are available in mini (1.750") or micro (.875") sizes.

Mini	Micro	Fuel Line
<b>77037</b>	<b>77039</b>	1/4"
<b>77038</b>	<b>77040</b>	5/16"

## Chrome Transmission Vent Canister

Accepts 5/16" or 3/8" hose.  
**59523**



# Petcocks

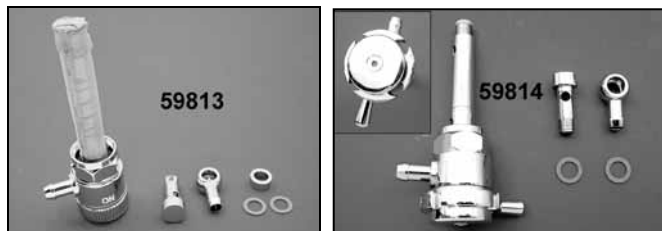

## Sifton Max-Flow Chrome Petcock

Features 360 degree swivel high capacity elbow, full reserve nut and delta knob valve control.

**PCP Style**

**59813** Round, ribbed cap

**59814** Round, notched cap



## Chrome Fuel and Petcock Cover

Chrome cover installs easily over fuel petcock.

**61222** 2002-06 carbureted models (62968-02)



## Sifton Chrome Ball Petcocks

Features a stainless steel ball mechanism that provides a secure on/off seal and prevents valve from freezing in the open or closed position. Available with 22mm nut for 1975-on and four outlet positions for any application. Also available with 6AN threaded fitting for fuel line hookup using stainless steel hose fittings.

**With 22mm Nut**

**PCP**

**21625**

**21626**

**21627**

**21628**

**With 6AN Fitting**

**21629**

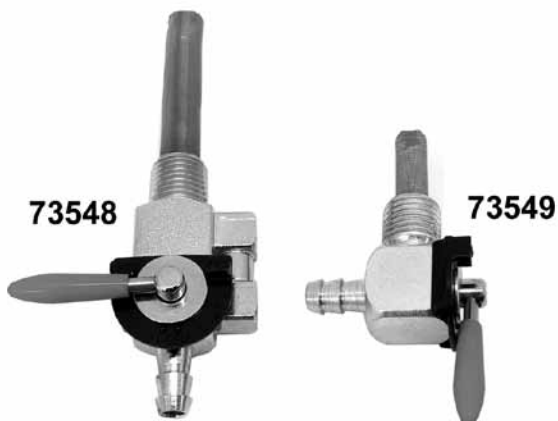

## Mini Petcocks

These petcocks are 1/4" NPT with a ball shut off

**73548** With reserve, straight down

**73549** With out reserve, 90 degree



## Chrome Billet Petcock

Features on/off and reserve positions.

**PCP Side**

**59810** Left

**59811** Right

**59812** Inward

# Petcocks



## Chrome Late Style Gas Petcock

Has Reserve and Screen. Fits FLH, FX 1975-92 and Sportster 1976-92.

**938** Straight outlet (62168-81)

**689** 90 degree outlet

### Hardware

#### PCP Description

**21611** Strainer with reserve tube (62166-81) (each)

**21613** Gasket (62172-75) (10 pack)

**79443** James, as above (20 pk)

**12593** Chrome nut (62161-02) (each)

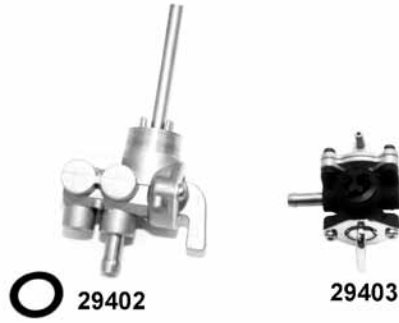

## Topline Replacement Petcocks

**29402** Stock finish as OEM without nut or filter (62129-75)

**29403** Stock finish as OEM with vacuum (61338-94D)

**29454** Stock finish as OEM FXST 2002-04 (61338-02)

**29455** Stock style XL 1995-on (62169-95B)

## "Viton" Petcock Seals

### 1975-94

This special seal fits behind gas tap faceplate to help eliminate the swelling problems associated with the various types of fuels available (including Ethanol type gasoline).

**25280** 10 pack

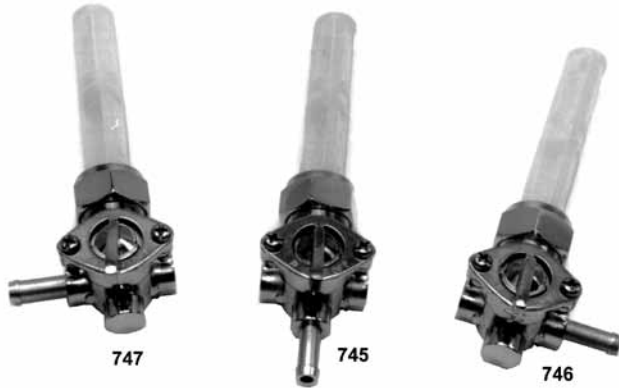

## Chrome Late OEM Type Petcocks

Including filter screen washer, and reserve position for 1975-92 gas tank with male thread outlet.

### PCP Outlet

**745** Straight (62168-81)

**746** Right (rear) (62167-81)

**747** Left (forward) (62169-81)

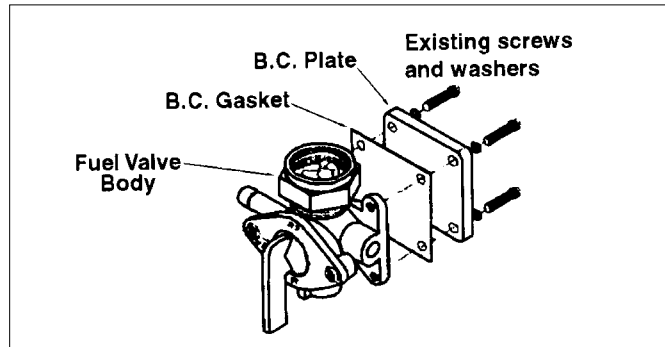

## Fuel Valve Body Vacuum By-Pass Kit

Includes plate, gasket, vacuum hose plug and instructions.  
**41022**



## Weld In Petcock Inserts

### PCP Type Thread

**73725** Male 1975-on

**73726** Female 3/8 NPT

## Delphi FI to Carburetor Conversion Fitting

Includes gas tank fitting to eliminate Delphi fuel injection and use a carburetor and late style petcock.

**10626**



## Accel High-Flow Fuel Spigots

High flow fuel spigots protect against fuel starve at higher RPM which can cause detonation and eventual engine failure. Accel recommends the installation of a high flow valve with any modification to the motorcycle that increases RPM and acceleration. Spigots features a 100 micron screen filter, on/off, reserve positions and a chrome housing. Available in two styles, straight and rotating, to fit all 1971-92 carb models.

### PCP Type

**28000** Straight

**28002** Rotates horizontally to allow positioning of the outlet at any angle for custom hose routing





## Pingel Inline Fuel Filters

These filters are available in chrome or polished finish, and are 1 1/8" long for a 5/16" hose.

- 21618** Chrome
- 21619** Polished
- 21620** Element

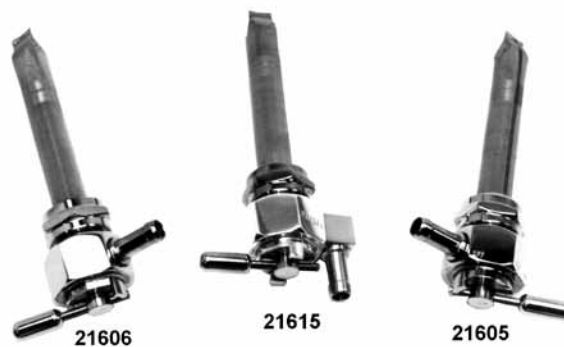

## Chrome Pingel Power-Flo Gas Valves

Body of 1-1/8" hex with a total length of 1-1/4". Hose adapter outlet is available with 5/16" hose ID size. O-rings insure leak proof seal. Stainless steel components with stainless steel fuel screen are included. 1975-on type includes nut.

Chrome	Polished	Years	#	Description
<b>21601</b>	<b>21609</b>	1975-on	U	with nut
<b>21602</b>	<b>21615</b>	1975-on	D	with nut
<b>21605</b>	<b>21607</b>	1975-on	L	with nut
<b>21606</b>	<b>21608</b>	1975-on	R	with nut
<b>21610</b>				Adapter Nut Only



## Pingel Vacuum Fuel Valve

This vacuum operated fuel valve is a direct OEM replacement and has the highest fuel flow of any vacuum style valve on the market. When the valve is left in the "ON" position with the motor off, the fuel flow will be shut off automatically. These valves are chrome plated and are metric with adaptor nut.

### PCP Application

- 21622** Left side mount hose outlets facing forward
- 21623** Left side mount hose outlets facing to the rear
- 21624** Left or right side mount hose outlets down

**Pingel Fuel Delivery Systems** Are Covered Under One Or More Of The Following Patents: 4,250,921 ; 4,957,138 ; other patents pending.

**R-Right:** Left side mounted, hose outlet facing back.

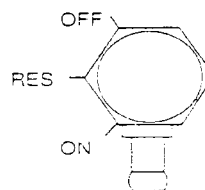

**U-Under:** Left side mounted, hose outlet facing right.

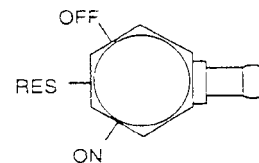

**L-Left:** Left side mount, hose outlet facing forward or right side mounted for Sportsters, hose outlet facing rear.

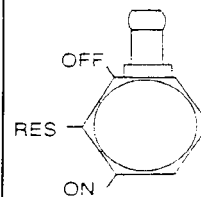

**D-Down:** Left side mounted, hose outlet facing right and down.

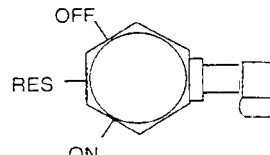

## Pingel Fuel Valve Rebuild Kit

This kit was designed to work with Pingel's single or dual outlet fuel valves. The Kit includes: rebuild parts for three valves, all tools needed, and instructions.

- 21616** Fuel valve rebuild kit, complete for 3 valves
- 21617** Fuel valve rebuild components for 5 valves

The appearance of these fuel valves are a trademark of Pingel Enterprise, Inc. Patents pending. Made in the USA.

## Pingel Power Flow Valve

One piece, billet, brass valve has a single outlet with "U" type reserve and a -6AN threaded fitting for fuel line hook up using S.S. hose and fittings. Line and S&S E & G carb fitting sold separately.

- 21621** Petcock
- 16271** S&S fitting



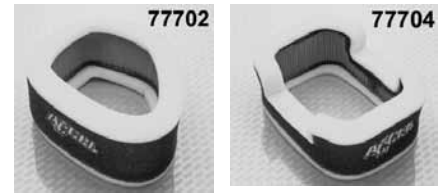

### UNI Foam Filters

Unique filter designed to replace the factory unit. Foam construction allows free flow of clean air to engine for maximum performance and a greater dirt holding capacity. These filters are easily washed for re-use. Finest quality, American made



### For Big Twin Models

Uni	Accel	K&N	Depth	Fits
-	-	77729		TC Touring 1999-01 EFI (29462-99)
-	-	77734	1-3/4"	TC Touring 1999-07 carb, all Softail 2000-06, 2002-07 EFI Touring, Dyna 2006-on (29461-99)
77750	77716	-	3-1/4	80" Evo 1993-00 round not EFI (29259-93)
6674	77709	77732	3-1/2	80" Evo 1989-92 round (29259-89A)
6668	77708	77731	3-1/2	80" Evo 1986-88 round (diamond shaped filter) (29259-86)
6665	77707	77730	3	80" Evo 1984-85 round (29259-83A)
6666	-	-	2-7/8	FLT, FLHT 1983-85 (Ham Can) (29288-83)
-	-	77748		Dyna 2008-on
-	-	77749		FLT, FLHR 2008-on

### For XL Models

Uni	Accel	K&N	Ht.	Fits
6662	77703	-	3	XL 1988-92 oval (29086-73)
6669	77704	77736	3	XL Evo 1988-03 oval (29036-88B)
6667	77702	77735	3-1/4	Evo 1986-87 oval (29036-86)

### For Aftermarket Models

Uni	Accel	K&N	Ht.	Fits
6670	77710	77738	2-3/8	S&S Super B & D
6673	77715	77739	2-3/4	S&S Super E & G
77719*	-	-		Kool blue as above
6671	-	-	2-3/4	S&S 2-Throat
6672	-	-	2	# 827 Air cleaner (Dragtron)
-	-	77740		Mikuni HSR 40 smoothbore
-	-	77741		Mikuni HSR 42/45 smoothbore
-	-	77742		Screamin' Eagle round (29055-89)
-	-	77743		Screamin' Eagle tapered
-	-	77745		Hyper Charger



### K&N Aerosol Recharger Service Kit

A six step maintenance system designed to recharge any K&N air filter. Restores air flow efficiency. Includes 6.5oz spray oil and 12oz filter cleaner.

**21832**

\* Accel's "Kool Blue" filters (plastic coated mesh, washable and reuseable)

# Air Filters

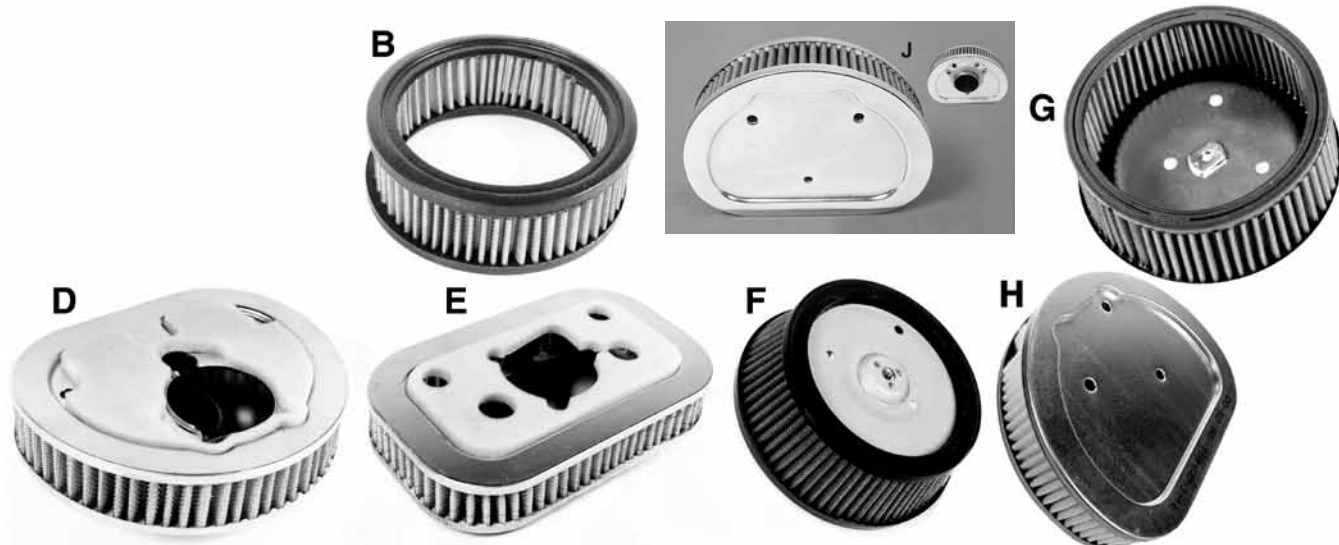

## Reusable Paper Air Filters

These washable paper air filters have the original shape and styling to ensure a proper fit.

PCP	Style	Application
77772	(D)	1990-98 FLST/C/F/N, FLT/C/U, FLHT/C/P/U, FLHS; 1991 FXDB-D/DC; 1991-96 FXDB-DL WG, 1990-93 FXLR, 1991-94 FXR/S/S-CON V/S-SP/T/C/D, 1984-90 FXST, 1989-93 FXSTS, 1990-95 FXSTC (29259-93,29259-91A)
77773	(H)	1999-01 TC Touring with carb and 2002-07 EFI Touring, all 2001-08 Softail (29461-99)
77774	(H)	PCP, as above (29461-99)
77775	(E)	1988-2003 XL (29036-88A)
77776	(B)	Round S&S type "B"
77782	(B)	Round S&S type "E & G"
77777	(F)	Tapered Velo type
77778	(G)	Sifton air power
77779	(H)	2002-on V-Rod (29437-01)
77780	(I)	1999-01 Touring EFI (29462-99)
77783	(J)	2008-on FLT, FLH (29633-08)
77781		2004-on XL (29331-04)



## K&N Air Filter Twin Cam 1999-01

Fits Twin Cam fuel injected models 1999-01.

77729

## S&S New Generation Air Filter Element

The new S&S Super E & G filter elements are made with the same filtering material used in many stock cars and drag racers. The new filtering media removes more airborne particles while allowing better air flow. The new filter media is also more durable and lasts longer because it can trap nearly twice as much dirt before becoming clogged. As an added bonus this material can be washed and reused several times before it needs to be replaced.

170054



## Hi-Flow Air Cleaner Element

Fits S&S E air cleaners. Kit includes washable 3.5" high filter and mounting studs.

77747

# S&S Air Cleaner

## S&S Teardrop Air Cleaner for Twin Cams

with stock carburetor and for 2002 fuel injected models. Owners of 1999-on Twin Cam style engines equipped with stock CV carburetors, 2001-on fuel injected Softails, and all 2002 fuel injected models can enjoy the performance benefit and good looks of an S&S teardrop air cleaner. S&S backplate bolts directly to the stock CV carb or the single throat style EFI throttle body.

Like other S&S air cleaners for stock carbs the Twin Cam style air cleaners feature a uniquely designed backplate with air horn style radiused entryway and a dimpled cover with air directional cone on the inside. Both features help maximize air flow by giving intake air an efficient, easy path to follow into the carburetor or throttle body. Harmful particles are captured by the foam filter element which can be washed out and reused. The air cleaner cover is finished in show quality chrome, which compliments the appearance of most motorcycles. Kits include instructions and all parts and hardware needed to complete the installation.



S&S teardrop air cleaner kit #170117 fits 1991-on Sportsters, 1993-on carbureted Evolution Big Twins, and 1999-on Twin Cam style engines with stock CV carbs in addition to 2001-on fuel injected Softails, and all 2002-on fuel injected models.



Application	Stock CV and EFI	S&S L, H-D, Tillotson, Bendix, Keihin	Super E&G	Super D
1999-on Twin Cam carbureted models			170403	
1993-99 Up carbureted Big Twin V2 models			170404	
1990-92 Big Twin V2			170399	170198
1984-89 Big Twin V2		170108	170399	170198
1991-on Sportster	170448		170404*	
1988-90 Sportster			170399	170198
1986-87 Sportster		170108	170399	170198
1994-02 Buell	170105			
Chrome cover only for Super E & G models			170378	

\*Must be used with 3/8" thick insulator block S&S 16-0497 or 16-0498 for sportster 1991-03



**S&S Paper Super E/G Element**  
170054



**S & S Aircleaner Cover**  
Screws, chrome plated.  
4736 Set of 3



### S&S Desperado Air Cleaner Cover

This stylish cover not only looks good but it also offers better performance. Can be installed without any jetting changes to a properly jetted carburetor.

**170004**

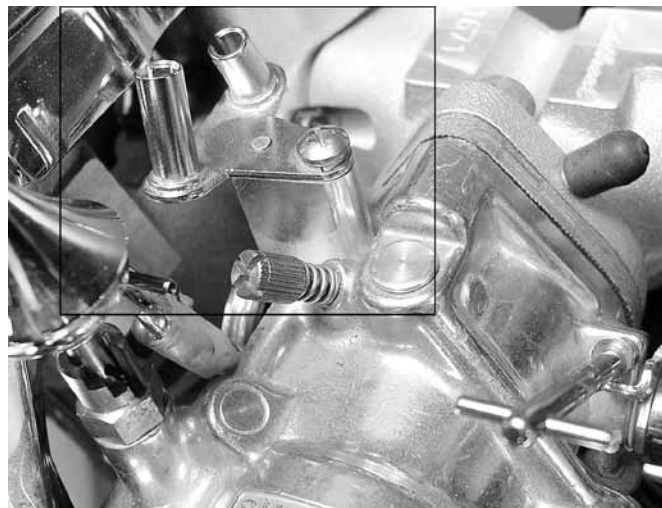

### S&S Throttle Cable Adapter Block

Allows use of stock 1996-on throttle cables on Super E carbs.

**16525** BT

**16536** XL

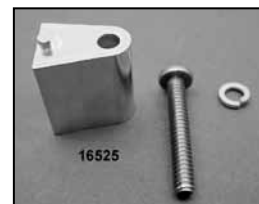

**24077**

**24078**

### S&S Super Allen Screw Set

Includes chrome bowl air cleaner and cover screws.

**24077** Super B

**24078** Super E & G



### Throttle Cable Adapter Kit

For use when fitting pre 1990 Edelbrock Qwiksilver carb on BT 1990-98 or XL 1988-98 with OEM throttle cables. Use on 1996-on S&S series carb to allow use of OEM cables.

**16535**

### S&S Enricher Assembly

This can be used on S&S Super E & G carbs when an aftermarket air cleaner or velocity stack is used. Does not require lever assembly. Features full on or full off operation only.

**73528**



### S&S Air Cleaner Mounting Screws

Chrome, buttonhead, countersunk allen screws. 3 Pack.

**9980**



### S&S Super E & G Velocity Stack Kit

Kit includes polished stack, bracket, and enricher knob.

**170485**



### S&S Style Carburetor Chrome Allen Screw Kit

Chrome plated smooth head allen screws replace the stock screws for a more decorative finish. Fits E and G models.

**72596**

# S&S Super E & G

## Compatible with Stock Throttle Cables on all Late Model Big Twins.

For the sake of safety, all S&S carbs are designed to use a two pull open/pull closed throttle system. Super "Shorty" carbs for Big Twins are compatible with stock 1981-on throttle cables. Carb kits for late model Big Twins, originally equipped with constant velocity (CV) carbs, include a taller throttle cable guide bracket that accomodates the longer CV style cables. Kits for earlier model Evolution Big Twins which could have been equipped with either a butterfly or CV type carb include both a shorter bracket for butterfly style cables and the tall bracket for CV style cables. Due to inadequate frame clearance the taller throttle bracket can not be used on Sportsters. Therefore, late model Sportsters and Buells require the installation of earlier butterfly style throttle cables.



**S&S Super E and G Complete Carburetor Kit Selection Chart**

Application	Year	Standard Super E Kit	Standard Super G Kit
BT	1984-92	110407	110427
	1993-99	110419	110434
Sportster	1986-90	110408	110428
	1991-03	110409	110429
	2004-05	110470	
Twin Cam 88	1999-05	110450	110451
	124" Motors only		110531
Carb Only	All	110420	110421

Note: OEM stock CV carb being replaced with an "E" or "G" will require use of the push-pull cable set-up, as stock on 1981-89.



### Cruise Control

Super "Shorty" carbs can easily be installed on motorcycles equipped with factory cruise control. Cruise control adapter kits are available for 1993-97 and for 1998-03 later models. The S&S cruise control kits make any Super E or G carburetor compatible with the stock H-D cruise control. Kits include all parts and instructions needed to complete the installation.

**112926** 1993-97

**112927** 1998-03



The original short throttle cable guide #112339 fits the 1981-89 style stock H-D and S&S "butterfly" style throttle cables for Big Twins.

The new longer cable guide #112338 fits the 1990-on "CV" throttle cables for Big Twins.



# S&S Super Rebuild



S&S Carb Type	Carb Model	Body Rebuild Kit	Accelerator Pump Kit	Master Rebuild Kit
<b>Super Series</b>	Super E Gas	<b>112906</b>	<b>112918</b>	<b>112923*</b>
	Super G Gas	<b>112907</b>	<b>112918</b>	<b>112924*</b>
	Super A & B Gas 1983-on (wire type mechanism)	<b>112903</b>		<b>112909</b>
	Super D Gas pre 1985 (forked type mechanism)			<b>112915</b>
	Super B Fuel, B Turbo Gas, Turbo Alcohol and fuel	<b>112908</b>		
<b>Two-Throat</b>	1983-on (wire type mechanism)	<b>112905</b>	<b>112916</b>	<b>112919</b>

\* Note: When these super master rebuild kits are used to update an early Super E or G equipped with a 360 degree variable position gas inlet fitting, S&S fuel line, #190474 or 190475, with a 90 degree formed end must be used and ordered separately

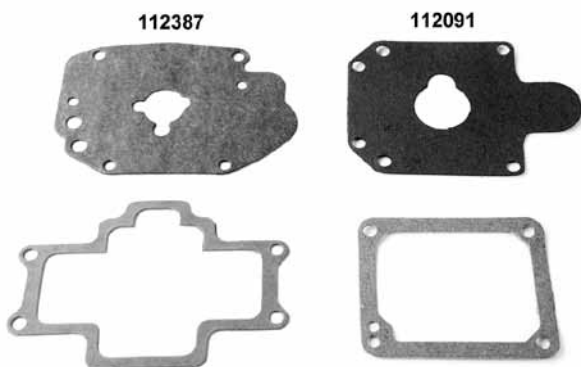

## S&S Bowl Gaskets

PCP	Application
<b>112387</b>	Super E and G (5 pack)
<b>112091</b>	Super B and D (10 pack)
<b>112290</b>	Two-throat (5 pack)
<b>112061</b>	"L" Series (5 pack)

## Intermediate Jets

Series 94 jets used to bleed air. Fits all super gas carburetors. Sold Each

### Intermediate Jets

PCP	Size
<b>16006</b>	.025
<b>16007</b>	.028
<b>16008</b>	.0295
<b>16009</b>	.031
<b>16014</b>	.032
<b>16010</b>	.033
<b>16011</b>	.036
<b>16012</b>	.040

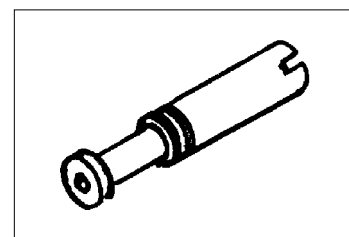

## Main Jets (Sold Each)

Use when installing new exhaust system or just tuning for better performance and mileage. For LS, Super Gas & alcohol, and Two Throat (Series #72)



### Main Jets.

PCP	Size	PCP	Size	PCP	Size	PCP	Size
<b>16022</b>	.044	<b>16028</b>	.056	<b>16036</b>	.072	<b>16044</b>	.088
<b>16023</b>	.046	<b>16029</b>	.058	<b>16037</b>	.074	<b>16045</b>	.090
<b>16024</b>	.048	<b>16030</b>	.060	<b>16038</b>	.076	<b>16046</b>	.092
<b>16025</b>	.050	<b>16031</b>	.062	<b>16039</b>	.078	<b>16047</b>	.094
<b>16026</b>	.052	<b>16032</b>	.064	<b>16040</b>	.080	<b>16048</b>	.096
<b>16027</b>	.054	<b>16033</b>	.066	<b>16041</b>	.082	<b>16049</b>	.098
		<b>16034</b>	.068	<b>16042</b>	.084	<b>16050</b>	.100
		<b>16035</b>	.070	<b>16043</b>	.086	<b>16051</b>	.102
						<b>16052</b>	.104

# S&S Super E & G



## S&S Throttle Assemblies 1981 and Earlier Chassis

Fits 1" diameter handlebars, S&S Super E & G; and all other butterfly type carbs with 1981-96 H-D style throttle linkage. Cables measurements are taken from throttle grip to end of cable housing, barrel fittings are soldered in place.

- 190449 48" cables
- 190448 38" cables
- 190482 42" cables

S&S Throttle Cables		Open Side	Close Side	Total Length	Hsg. Length	Description
190432	190433	36"	32"	To 1995, 1981-85 FX and FL		
190436	190437	36"	32"	1996-on 883-1200 XL		
190434	190435	39"	35"	Softail (FXSTC, FXST, FLSTC, FLSTF) to 1995		
190438	190439	39"	35"	FXR 86-94, Dyna 93-95		
190446	190447	42"	38"	FXST/C, FLSTC, FLSTF, Dyna 1996-on		
190440	190441	42"	38"	To 1995 custom use		
190462	190463	48"	44"	1996-on custom use		
190464	190465	48"	44"	All FLT to 1995		
				All FLT 1996-on and custom applications		

Note:

1. Actual cable fitment may vary with the use of aftermarket bars, frame modifications, etc.
2. The "Total Hsg" length includes both the bent metal housing and vinyl carrier together. "Vinyl Hsg" length is for the carrier only



## S&S Main Jets

PCP	Size (5 pack)
117231	.062
117232	.064
117234	.068
117238	.076



## S&S Manifold Kit for 1984-89 80" Evolution

Converts stock rubber compliance fittings to a more rigid mount system, kit includes S&S manifold, mount flanges, 2 specially molded O-rings, and 2 .350" spacers for spacing out the stock air cleaner or carb mount bracket. This manifold is included in our super kit for Evo 1340cc.

- 161658 BT Evo
- 161650 Sportster 1986-on

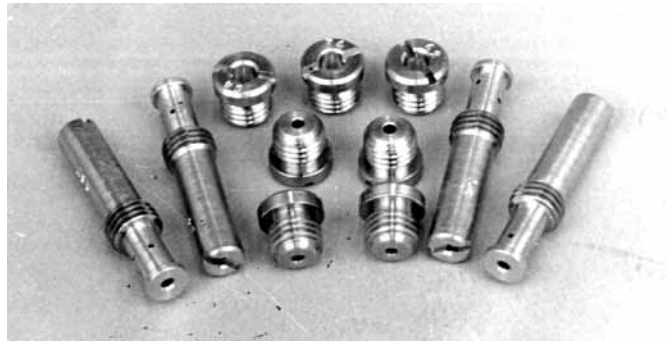

- 117270 Low range jet pack for jetting most stock and moderate performance engines up to about 93" displacement
- 117271 High range jet pack for jetting some stock and all performance engines.
- 117272 Master jet pack for jetting all Super E and G equipped engines (this jet kit will also service most engines equipped with Super Bs)



## S&S 1" Spacer Support Kit

Required for Evolution or Twin Cam engines with head breather style heads using S&S Super E or G air cleaners.

160058



170486



170487

### S&S Breather Conversion Kits

Conversion kits include banjo fittings that are sealed with silicone washers which offer a much better seal and greater durability than o-rings. These kits also offer easier air cleaner servicing because the banjo fitting and breather hose are mounted on the cylinder head before the air cleaner back plate is installed and do not need to be removed during servicing. Fits Super E and G cleaner kits 1993-99 BT, 1990-on XL and can be used to retrofit earlier S&S air cleaners. XL kits include a special insulator block and longer manifold bolts.

**170486** BT 1993-99

**170487** XL with 1-7/8" carbs 1991-2003

**170488** XL with 2-1/16" carbs



161651

### S&S Manifold #366

For cylinder lengths of 4.830", 79" Retro +100".

**161651** 1-7/8" Rigid mount for XL 1986-on



### S&S 1-7/8" Rigid Mount V2 Manifold FL 84-99

For cylinder length 5.375", 88" and 107" BT 1984-99.

**161626**



### S&S Paper Super E/G Element

**170054**



### S&S Super E Chrome Cover for 5 Gallon Tanks

**170372**



### S&S Super E Chrome Cover FL 1993-99

**170378**



### S&S Super E Evo Backing Plate FL 1984-91

**170380**



### S&S Air Filter Adapter Kit

The high flow filter is 1" taller than our standard filter and features a low restriction, pre-oiled filter element. The low restriction element and larger surface area increase airflow by 37% over S&S's standard filter. The filter and filter adapters extend the teardrop housing out 1". The resulting band of exposed filter peeking out from under the teardrop imparts a high performance street racer look. Kit installs in minutes with no permanent modifications required. These kits are not for use with Super B or D carburetors or Super E and G kits for Buells.

**170045** For S&S Super E and G carburetors

**170055** Replacement filter



## Insulator Blocks

1-7/8" Opening with mounting hole pattern that is identical to stock pattern on Tillotson, Bendix and Keihin butterfly type carbs. Use with all S&S 1-7/8" manifolds. Includes o-ring.

- 160491** 1/4" Thick
- 160497** 3/8" Thick Super E

2-1/16" Opening. Use with all S&S 2-1/16" manifolds, includes o-ring.

- 160492** 1/4" Thick
- 160498** 3/8" Thick Super G

2-1/4" Opening. Use with all S&S 2-1/4" manifolds, includes o-ring.

- 160499** 1/4" Thick



## S&S Throttle Cable Brackets

These brackets allow the use of stock type cable on S&S E & G carbs.

- 73587** Fits 1981-89 Short type
- 73588** Fits 1990-on Long type

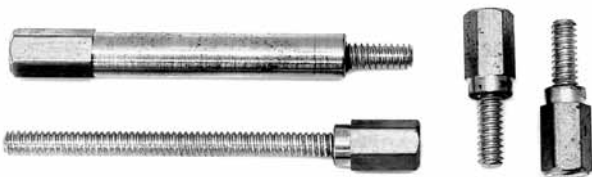

## Long Float Bowl Screws for Super E

This facilitates easy removal of float bowl

**73536**



## Idle Adjustment Cables

Includes housing and spring clip. Fits S&S Super E with holder stay.

**41039**



## Adjustable Main Jets For S&S

Fits in the float bowl drain plug below the main metering jet. The recommended main jet is 100 to 104.

## Adjustable Enricher for S&S

Replaces the stock fixed enricher, adjusts as bike warms up, and also makes for easier starting. O-rings and instructions included.

PCP	Description
<b>1254</b>	Enricher
<b>3823</b>	Main jet
<b>530452</b>	Jet installer and removal tool on all B & E carbs



## Sifton Carb Hop Up Kit

Kit includes emulsion tube and bomb sight annular booster tube for all S&S E carbs.

- 73505** Kit
- 73593** Idle mixture screw



## S&S Adjustable Carb Bracket for 'E' & 'G' Models

**73589**

## Sifton Enricher for S&S

Fits Super E & G and B carbs, includes chrome knob.

**73586**





**For S&S E Chrome Velocity Stack Kit**  
Includes bracket with integral passages. Enricher knob included.

**PCP Item**  
**21791** EV and TC-88



**S&S 1" Manifold Spacer Block**  
**160357** Sold each



**Chrome Alloy Velocity Stacks (not by S&S)**

PCP	Size	Application
<b>59007</b>	2.5"	S&S "E/G"
<b>59008</b>	4"	S&S "E/G"
<b>59009</b>		Chrome choke knob



**Super Gas Model A & B Body Rebuild Kit**  
Use on all S&S 1-7/8" Super carbs. Each kit contains 1 ea. throttle shaft, 2 ea. throttle shaft bushings, 1 ea. throttle plate, 1 ea. throttle return spring, 2 ea. throttle plate screw, 1 ea. O-ring, 1 ea. bowl gasket. These kits are for super "A" "B"

**41005** Preston  
**112903** S&S

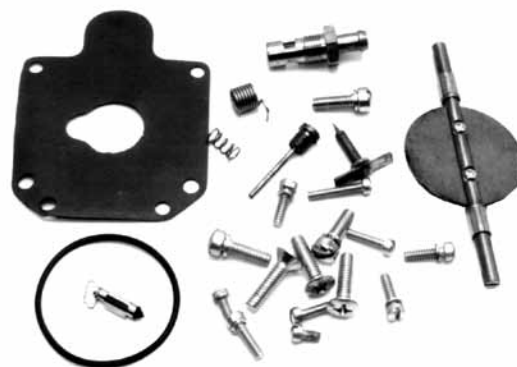

**Super Gas Model A & B Body Rebuild Kit**  
Use on all 1-7/8" Super Carbs. Each kit contains 1 ea. throttle shaft, 2 ea. throttle shaft bushings, 1 ea. throttle plate, 1 ea. throttle return spring, 2 ea. throttle plate screw, 1 ea. O-ring, 1 ea. bowl gasket. These kits are for super "A" "B"

**112909** S&S  
**16015** Preston

# Super E and G Replacement Parts

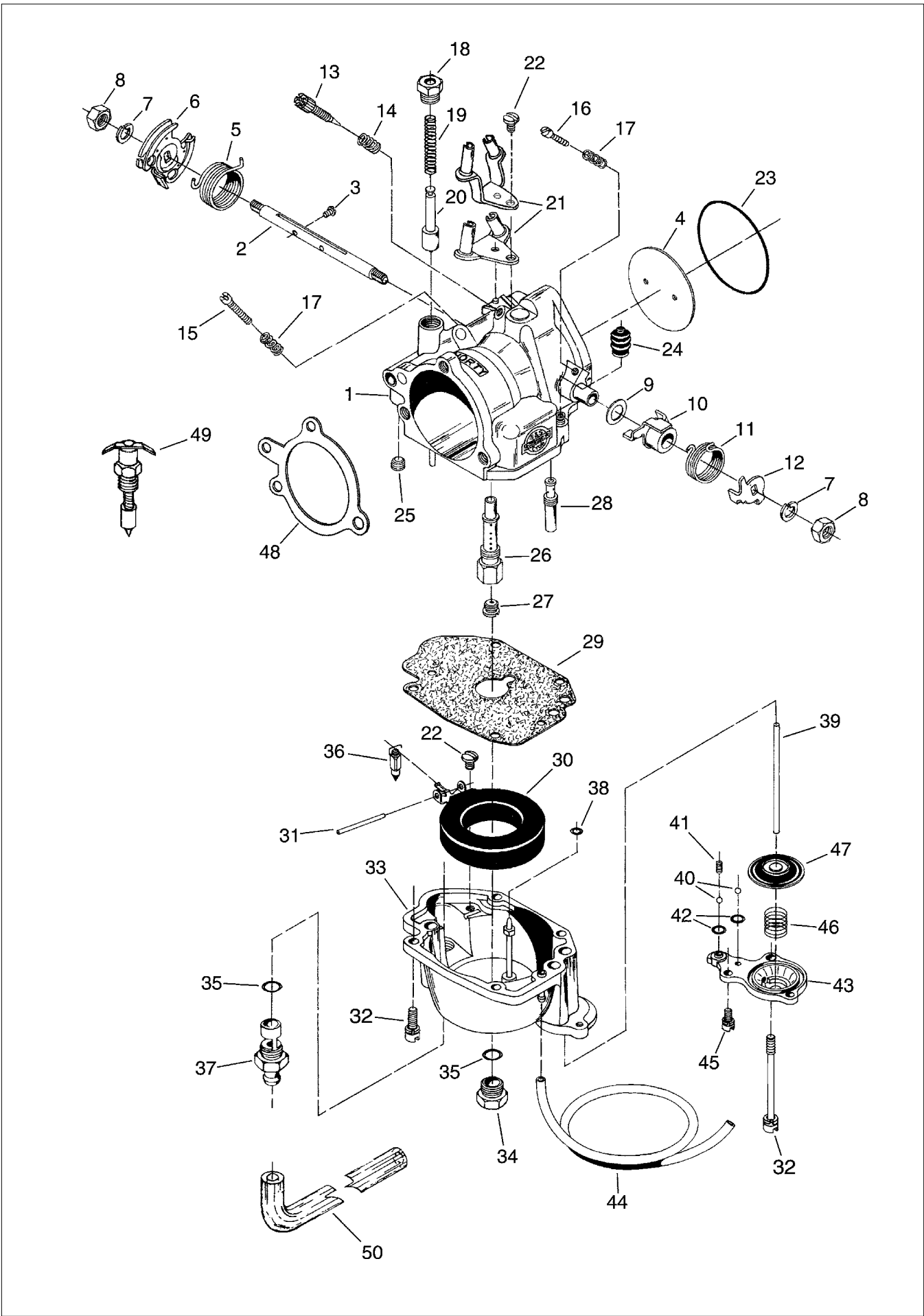

# Super E & G Carburetor Replacement Parts

- |   |   |   |
|---|---|---|
| 1. Carb body assembly<br>1-7/8" E ..... <b>112381</b><br>2-1/16" G ..... <b>112390</b>  | 23. O-ring<br>1-7/8" E (10 pack) ..... <b>508094</b><br>2-1/16" G (10 pack) .... <b>508093</b>  | 45. Pump cap screw 8-32 (2 required)<br>(10 pack) ..... <b>500098</b>   |
| 2. Throttle shaft<br>(includes 2 plate screws)<br>1-7/8" E ..... <b>112383</b><br>2-1/16" G ..... <b>112483</b>   | 24. Bellows seal (5 pack) ..... <b>112279</b>   | 46. Diaphragm sprig (10 pack) .. <b>112278</b>  |
| 3. Throttle plate screw (2-required)<br>(10 pack) ..... <b>500064</b>   | 25. Bowl vent plug (10 pack) .... <b>500151</b>   | 47. Diaphragm ..... <b>112282</b>   |
| 4. Throttle plate<br>1-7/8" E ..... <b>112055</b><br>2-1/16" G ..... <b>112355</b>  | 26. Main discharge tube ..... <b>112085</b>   | 48. Gasket, backing plate<br>(10 pack) ..... <b>170383</b>  |
| 5. Throttle return spring ..... <b>N/A</b>  | 27. Main Jet .... see pages 9-34 to 9-35  | 49. Enrichment device<br>Use with air horn only ... <b>112084</b>   |
| 6. Throttle spool ..... <b>112385</b>   | 28. Intermediate jet ..... see page 9-34  | 50. Fuel line w/90 degree bend*-19"<br>Use with 112465 or 112466<br>..... <b>190475</b>   |
| 7. Throttle shaft lock washer (2 required)<br>(10 pack) ..... <b>507073</b>   | 29. Bowl gasket (5 pack) ..... <b>112387</b>  |   |
| 8. Throttle shaft nut (2 required)<br>(5 pack) ..... <b>N/A</b>   | 30. Float ..... <b>112187</b>   |   |
| 9. Throttle shaft nylon washer<br>(10 pack) ..... <b>507072</b>   | 31. Float pin (5 pack) ..... <b>112370</b>  |   |
| 10. Pump actuator lever ..... <b>112376</b>   | 32. Bowl screw (10 pack)<br>10-24 x 3/4" (3 used).... <b>500063</b><br>10-24 2-3/8" (1 used) <b>500061</b>  |   |
| 11. Actuator spring ..... <b>N/A</b>  | 33. Carb bowl assembly ..... <b>112388</b>  |   |
| 12. Pump actuator arm..... <b>112377</b>  | 34. Bowl plug (5 pack) ..... <b>112092</b>  |   |
| 13. Idle mixture screw (Each) <b>112378</b>   | 35. Seat o-ring (required w/112465 &<br>112466 only when replaces 360 degree<br>style fuel inlet (5 pack) ..... <b>508095</b>   |   |
| 14. Idle mixture screw spring<br>(10 pack) ..... <b>112060</b>  | 36. Needle<br>1-7/8" E & 2-1/16" G .. <b>112195</b>   |   |
| 15. Idle speed screw (10 pack) <b>500150</b>  | 37. Seat<br>1-7/8" E & 2-1/16" G (Replaces 112347)<br>Uses 112195 needle ..... <b>112465</b><br>Racing only (replaces 112348)<br>uses 112197 needle ..... <b>112466</b><br>Racing only threaded fuel inlet,<br>.157" ID for Super E or G<br>uses 112195 needle ..... <b>112395</b><br>Racing only threaded fuel inlet,<br>.235" ID for Super E or G<br>uses 112197 needle ..... <b>112396</b> | * Early Super E & G carburetors<br>equipped with a 360 degree fuel inlet<br>that require service must be converted<br>to the bottom feed style fuel inlet. To<br>update production Super E and G<br>carburetors equipped with a 360 degree<br>style inlet use 1 of #508009 o-ring, 1 of<br>#112465 seat, and 1 of #190475 fuel<br>line. |
| 16. Pump adjustment screw<br>(10 pack) ..... <b>500146</b>  | 38. Ejector nozzle o-ring<br>(10 pack) ..... <b>508096</b>  |   |
| 17. Idle speed/pump adjuster spring<br>(10 pack) ..... <b>112053</b>  | 39. Pump pushrod (5 pack) ..... <b>112393</b>   |   |
| 18. Plunger nut (Each) ..... <b>112372</b>  | 40. Ball check 2 required<br>(10 pack) ..... <b>508125</b>  |   |
| 19. Plunger spring (10 pack) .... <b>112359</b>   | 41. Ball check spring (5 pack) .. <b>112392</b>   |   |
| 20. Fast idle plunger ..... <b>112343</b>   | 42. Pump cap o-ring (2 required)<br>(10 pack) ..... <b>508100</b>   |   |
| 21. Cable guide assembly<br>For use w/butterfly style cables<br>..... <b>112339</b><br>For use with CV cables-<br>(constant velocity style) . <b>112338</b> | 43. Pump cap assembly ..... <b>112389</b>   |   |
| 22. Cable clamp/ float pin screw<br>(10 pack) ..... <b>500062</b>   | 44. Overflow hose per 24"<br>(Each) ..... <b>190263</b>   |   |

# Carbs



## Keihin CV Carburetors

Quality Japanese manufactured carbs feature dual cable operation and are available for XL and BT models.

**41402** BT 38mm (27421-99C)



## Topline Big Bore 44MM CV Carb Kit

Constant velocity carb features a 44mm bore to allow air and fuel delivery even at high RPMs. Installs easily using stock cables but an intake manifold must be ordered separately to ensure proper fitment. Exceptional low and mid range power for race applications. (27934-99)

**68400** BT 1990-on & Twin Cam 88 1999-on (27934-99)

**68401** Intake manifold TC-88 1999-on (29635-99)

**68402** Intake manifold Evo 1340 1990-99 (29636-99)



## Mikuni HSR 42 and 45 Total Kits for BT

These kits are complete with all required parts for installation. Kits include HSR 42mm or 45mm carburetor, intake manifold, rubber flange, K&N filter, chrome cover, breather kit and mounting hardware. 1990-on models use stock throttle/idle cable and 1984-89 models require 1990-on cables.

**42mm**

**PCP Description**

**59998** 1984-99 BT

**59999** 1999-06 TC

**45mm**

**59993** 1984-99 BT

**59994** 1999-06 TC



## Carb Related

**29121** Fuel valve diaphragm 1997-on (61200-97)

**14596** Carb plate o-ring BT 2000-on (11292)



## Choke Cables

**29118** BT 1988-04 choke cable only (29229-88D)

**29123** BT 1988-04 complete choke cable

# CV Accessories



## CV Carb Upgrade Kit

Includes rebuild kit, vacuum piston, screws and tuner kit. Fits 1988-on Keihin CV carbs.  
41010



## T/L 44mm CV Carb Rebuild Kit

68403 27554-99

## Chrome Choke Cable Mount 1993-99

Replaces 69126-92 on 1993-99 FLT-FXST/D models.  
27320



## System II Atomizer

Screening device which further mixes fuel at face of manifold. The tossed mixture burns more efficiently and completely.

### PCP Application

59727 S&S, Mikuni, 40mm Screamin Eagle, 40mm  
59728 All CV carbs



## S&S CV Carburetor Jet Kits

PCP	Application
115200	1988-03 XL 883, 1200
115201	2004-on XL 883, 1200
115202	1990-98 BT
115203	1999-on BT



## CV Carb Rebuild Kit

Kit includes seals, o-rings, diaphragm and vacuum piston.  
41008

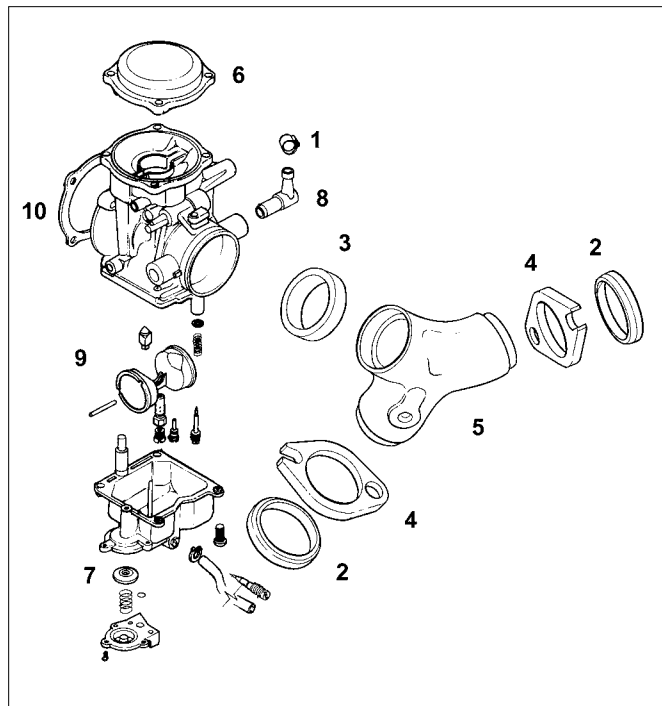

## CV Carb Parts FLT, FXR, FXST, Dyna

#	PCP	Description
1	16222	Gas line clamp (10014) (10 pack)
2	14030	Seal, intake manifold to head (26995-86A) (5)
3	14102	Seal ring, carb to manifold (27002-89)
4	41002	Flanges, front and rear (plain) (27009-86A, 27010-86A)
	41003	As above, chrome
5	41032	Manifold, plain (27019-89)
6	21512	Top, chrome cover 1990-99 and 1999-2006 TC (27040-88)
7	41019	Diaphragm, accelerator pump (27361-76)
	79118	James, as above
8	16058	Fitting (27371-76)
9	29163	Float 1989-91 (27576-88)
	29164	Float 1992-on (27576-92)
10	79190	James gasket 1988-on (29059-88) (10 pk)
	25186	Preston as above
	79519	Gasket, injector type 1995-on (29095-95) (5 pk)
	79546	Gasket, 1995-on (29062-95B) (10 pk)

## Extended Float Bowl Kit

Fits CV carbs for extra capacity and includes Hi-Flow inlet fitting.  
59729



# CV Accessories

41015



41011



## Dynojet

Dynojet carb recalibration kit for stock carbs will work with mild cams, stock or aftermarket exhaust and stock or aftermarket air cleaner.

### PCP Description

- 41011 XL 883-1200 1988-89 (non Accel pump)
- 41012 XL 883-1200, 1340 40mm 1989-95 with Accel pump
- 41013 883 1989-99 with Accel pump disabled (race only)
- 41014 883-1200, 1340 1996-00 with Accel pump
- 41015 .001 BT Evo 1990-99 Thunder Slide kit with Accel pump
- 41016 XL 1200 (not sport) 1996-03 Thunder Slide kit
- 41023 Twin Cam 88 1999
- 41024 Twin Cam 88 1999 Thunder Slide kit
- 41025 Twin Cam 88 2000-on
- 41026 Twin Cam 88 2000-on Thunder Slide kit

## Kinetic-Karb CV Tuner Kit 1989-99

Tuner kit fits 1989-on Keihin constant velocity carbs, permitting easy tuning of custom air cleaners, cams and exhaust. Kit includes instructions, 3 main jets, needle jet, adjustable needle with spacers and circlips, and spring and drill bits. Dual purpose kit accomodates 1989 models without accelerator pump and 1990-on with accelerator pump.

41021

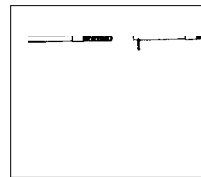

## Keihin and CV Idle Screw

Screw provides easier hand adjustments.  
26108

## Keihin Carb Fuel Inlet Fitting

Stock replacement fuel inlet fitting presses into carb body. Sold Each.

- 16057 XL1983-87 (27594-76)
- 16058 BT 1981-on, XL 1988-on (27371-76)

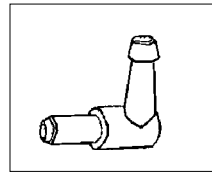

## CV Main Jets (5 pack)

- | PCP   | Size (mm)       |
|-------|-----------------|
| 16068 | 1.60 (27152-89) |
| 16069 | 1.65 (27116-88) |
| 16070 | 1.7 (27115-88)  |
| 16071 | 1.75 (27090-89) |
| 16072 | 1.80            |
| 16073 | 1.85 (27185-90) |
| 16074 | 1.90            |
| 16075 | 2.00            |

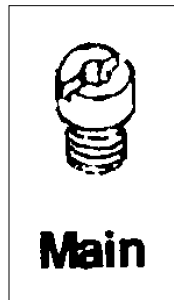

## CV Slow Jets (5 pack)

- | PCP   | Size (mm)       |
|-------|-----------------|
| 16076 | .040 (27281-92) |
| 16077 | .042 (27171-89) |
| 16078 | .044            |
| 16079 | .045 (27170-89) |
| 16080 | .046            |
| 16081 | .048 (27165-90) |

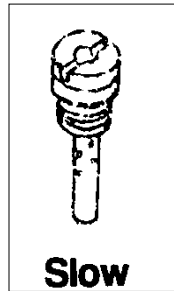

## Yost CV Carb Tops

Features built-in choke cable mount.  
44125

## Chrome CV Carb Top

Fits XL models from 1988-06 as well as all 1990-00 BT Evo and 1999-06 Twin Cam with CV carbs.

- | PCP   | Type              |
|-------|-------------------|
| 21512 | Smooth (27040-88) |



## CV Choke Cable Bracket

Will mount the knob assembly on top of carb for use with all air cleaners.

73733





### Yost Carb Power Tube

Add performance to your S&S and Keihin carbs by atomizing incoming fuel to a fine mist with Yost's solid brass Power Tube. You get better combustion, enhanced throttle response and a smoother engine. Instructions included.

**41017** All S&S B,E,G

**41018** Race kit Keihin CV-40mm on BT 1990-95 and XL 1988-95



### Carb Rebuild Kit for Keihin CV

A brand new rebuild kit for all Big Twins and XL models using the CV carb. The kit includes all the necessary needles, O-rings etc... for a complete rebuild. Sold each.

Fits 1988-06 XL and 1990-06 Big Twins.

**23505** Rebuild kit for all CV carbs

**79824** James Keihin carb rebuild kit 1988-06 27006-88

**14574** Carb bowl O-ring 1988-91 (27577-88) (10 pack)

**14575** Carb bowl O-ring 1992-on (27577-92) (10 pack)



### "CV" Manifold "O" Ring Kit

Includes 2 of 26996-86A & 1 of 27002-89

**14200** 3 piece kit

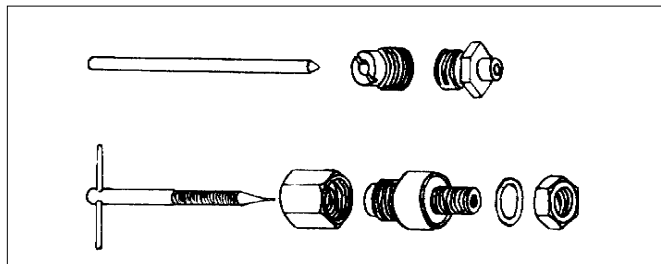

### Keihin Adjustable Main Jet

Full adjustability for maximum tuning efficiency. As pictured.

**16098**



### Intake Manifold Flanges for Evolution® Models

These intake manifold flanges will replace the stock parts on Evolution® Sportster® models 1986-95 and Evolution® Big Twins from 1990-95. They may also be used on RevTech™, HES Performance and S&S manifolds for Evolution® models.

#### PCP Description

**41002** Plain flanges (27009-86A, 27010-86A)

**41003** Chrome flanges

**14030** Seals (26995-86A) (5 pack)

# Keihin

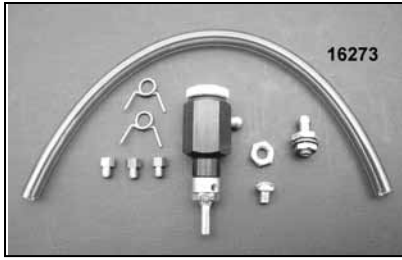

## Thunder Jet Accelerator Jet & Accessories

Mounts in all Bendix-Keihin, S&S, Flowmaster, Tillotson and CV carbs; choke must be deleted for use. Works on Venturi vacuum principle as a third jet. Extra jets included.

- 16273** Thunder Jet Bendix Keihin, S&S E series
- 16274** Replacement fuel tube
- 16275** Set of 3 air bleed jets for S&S Super E & G. Includes 1 each of .135, .150, & .160
- 16276** Thunder jet for CV carb
- 16279** Jet tool, all



## Float Bowl Screws for Keihin Carburetors

If you change Keihin jets, this kit should be bolted on. Includes an allen wrench, and has a flat black finish. Fits all Keihin.

- 4747** Socket screw set 1976-89 (not CV carbs)
- 24064** Socket screw set 1989-on (CV carbs)



## High-Flow Accelerator Pump Kit for Keihin Carburetors (not for CV) 1980-88

This kit improves the performance of stock Keihin carbs. Fits 1980-88 Big Twin and 1980-87 Sportster® models. Bolt on extra power by simply removing the float bowl, drilling one small hole in it, and installing this high performance accelerator pump body. Low and mid-range throttle response are noticeably increased. Matte finish.

- 269050** Accelerator pump kit

## Air Cleaner Mount Gaskets

- |              |                                      |
|--------------|--------------------------------------|
| <b>PCP</b>   | <b>Years</b>                         |
| <b>25096</b> | 1977-87 (10 pack) (29058-77)         |
| <b>25186</b> | 1988-on CV type (10 pack) (29059-88) |



## Adjustable Main Jet for Keihin Carb

Eliminates the chore of "hit and miss" multiple jet changes when changing pipes or air cleaners on all Keihin equipped Harley-Davidson models 1976-on. Full adjustability allows precise tuning for maximum performance with every combination of engine, pipes and air cleaner. This kit frees you from the limitation of the few fixed jet sizes available and the labor of drilling jets. Use new gaskets and seals when installing, supplied in our rebuild kit. Our installation tool correctly marks the float bowl for proper fit.

- 3820** Complete kit (shown)
- 5784** Adjustable needle only (includes 180mm jet)
- 3825** Installation tool only

## Keihin Low Speed Jets 1976-89 (not CV)

PCP	Size (mm) (each)
<b>16060</b>	.065 (27896-79)
<b>16061</b>	.068 (27894-78)
<b>16063</b>	.072 (27897-78)
<b>16064</b>	.075 (27382-77)
<b>16065</b>	.080
<b>16066</b>	.088 (27348-77)
<b>16067</b>	.100

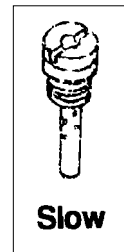

## Keihin Main Jets for Harleys

Preston now provides Keihin main jets in four needed sizes for 1976-on Harleys.

PCP	Size (mm) (each)
<b>3821</b>	1.65 (27419-76)
<b>3824</b>	1.70 (27418-76)
<b>3826</b>	1.75 (27417-76)
<b>3828</b>	1.80 (27416-76)

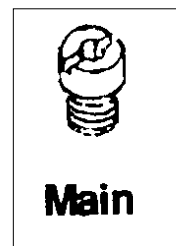

## Carb Float 1978-88

- 29162** 27887-78



## Slow Jet Screw Driver

Facilitates removal of Keihin slow jets without damaging jet.

- 26135**

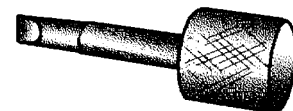

# Carburetor Accessories



## Deluxe Keihin Carb Kit

Fits BT 1976-89 and XL 1976-87 all models. Does not fit CV.

- 844** Complete Kit
- 79823** James
- 41019** Preston diaphragm pump only
- 29028** T/L Fuel valve w/clip only (27886-78A)

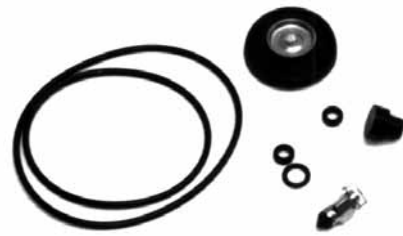

## Keihin Carburetor

PCP	Item	Fits
<b>835</b>	Rebuild kit	1976-86 Keihin (not Flowmaster or CV) (27006-76)
<b>14542</b>	O-rings	Float bowl 1983-87 XL; 1984-89 BT (27324-83) (10 pk)



## Vacuum Switch Assembly

PCP	Description
<b>66408</b>	1984-90 FXR (26557-83)
<b>66409</b>	1986-93 all XL, 1984-90 FXST (26558-84)
<b>66404</b>	1985-89 FLT (26555-84)
<b>66405</b>	1990 only all FLT (26555-90)
<b>66406</b>	1991-93 all FLT (26555-91)
<b>66407</b>	1994-98 all FLT, FLHT (not injected) (26555-94)
<b>66411</b>	1991-95 all FXST, Dyna, FXR (26566-91)
<b>66410</b>	1994-on XL (26558-94)
<b>66415</b>	1996-99 FXST (26566-96)
<b>66416</b>	1996-98 Dyna (26569-96)



## Accelerator-Idle Adjusting Screws

"T" handle design allows for easy adjustment of the idle and accelerator pump. Use the long screw for the idle and the short screw for the accelerator pump on S&S G carbs. A single idle screw is available for Bendix, Keihin/CV models.

PCP	Description
<b>26101</b>	S&S G
<b>26107</b>	Bendix
<b>26108</b>	Keihin & CV



## Compliance Fittings

Replacement compliance fittings with extra-thick flanges to eliminate leakage at the head surface. Fit Big Twin 1984-89. Sold in pairs.

- 1326** 27008-83A, 27012-83A

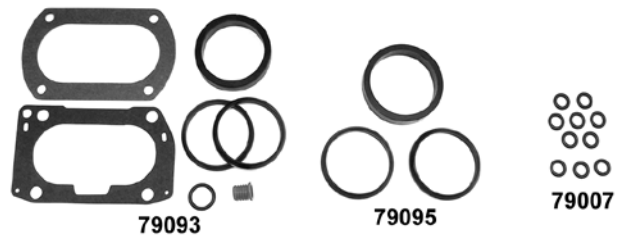

## James Twin Cam Carburetor Gaskets

PCP	Year	Engine	Description
<b>79093</b>	1999-on	1450cc 1550cc	Intake manifold carb seal kit
<b>79007</b>	1999-on	1450cc 1550cc	Upper fuel injector o-ring (10pk)
<b>79008</b>	1999-on	1450cc 1550cc	Centre fuel injector o-ring (10pk)
<b>79095</b>		44mm 45mm	CV Intake manifold carb seal kit Mikuni

# Carburetor Accessories

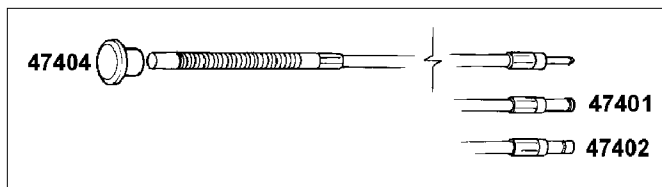

## Choke Cable FLH, FXST, FLT

Cable assemblies include knob, casing, and inner wire.

PCP	Description
47401	FXST 1984-85, FXWG 1985-86 (29213-79)
47402	FXST 1986-89 (29211-86)
20014	FLT, FXST 1990-92 (29236-90)
20015	FLT, FXST 1993-on, FXR 93-94 not FI (29229-88C)
29123	FLT, FXST 1993-04, FXR 93-94 not FI (29229-88B)
47404	Chrome knob FXST 1984-89 (29214-71)
23022	Rubber grommet FXST 1982-89 (27451-82)
12594	Nut FLH, FXST 1984-89 (27450-82) (each)
11013	Retaining ring FXST, FLT 1979-89 (11019) (10 pk)

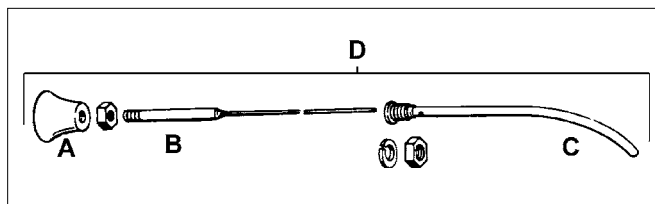

## Choke Cable XL, FXR

PCP	Description
20012	(D) XL 1986-87 (29229-86)
29123	(D) XL 1988-91, FXR 1993-on, Dyna 1991-05 FLT & Softail 1988-04 (29229-88C)
29118	(D) XL 1992-on (29229-88D)
20014	(D)FLT, FXST FXR 1990-92 (29236-90)

## Air Cleaner Screws

1/4 x 20 S&S Style screws.  
4736 (3pk)



## Turbulator

The turbulator turns the intake manifold into a violent mixing chamber. The heavier fuel particles are directed away from the sides of the manifold and back into the centre of the air flow. The fixed valve then tumbles the mixture resulting in higher horsepower.

PCP	Description
41000	38mm 2 bolt fits Keihin and Bendix
41004	40mm 2 bolt S&S Super B and E, and flat slide Mikuni
41009	CV all Keihin



## Quick Change Float Bowl Screws

For S&S Super B & D models to facilitate jet changes by easy bowl removal. Includes 4 knurled screws with large slots in satin finish.

41001 Set of four

## Cable Blocks

Used to attach inner cable to carburetor. Complete with screw and cotter key. Replaces OEM 27450-36, 27719-67 and 27716-67.

1503 Sold Each



## Sifton Idle Speed Knob for HSR 42/45

73535



## S&S Enricher

S&S Super E and G features 3 position with pike knob.  
73731



## Complete Choke Cable Assembly BT 1988-04

Includes cable, cable guide, sealing cap, starter valve, starter cap and enrichment spring.

21812	VT
29123	T/L

# Manifolds & Adaptors



## Stock Intake Manifolds

Cast alloy. USA made.

### PCP Application

**41032** Evo 1340 1990-on spigot type (27019-89A)

**41033** XL 1988-on spigot type (27004-88A)

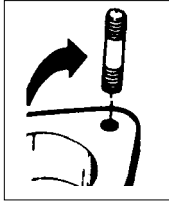

## Carb Mount Studs

PCP	Size	Application
<b>10842</b>	5/16 x 1-3/4	1978-85 (29253-78) (pair)
<b>10876</b>	5/16 x 1-1/4	1978-89 (29254-78)



## Manifold Repair Rings

Adapter rings for repairing the lips on the head and intake manifold. They may also be used in customizing, to adapt early-type manifolds to late-type heads and vice-versa. The stroker rings can turn a stock manifold into a stroker manifold for .200" taller cylinders or stroker plates. Adapter and stroker rings are available in pairs.

**3273** Adaptor rings

**3280** Stroker rings



## Rubber Flange Adaptors (not for HS40's)

**1968** 36-38mm

**1969** 40-44mm



**2090**

**2091**

## Carb Manifold Adaptors

Fit with our #1303 Manifolds.

**2090** 36mm to 38mm stepped manifold adaptor

**2091** 40-44mm straight through manifold adaptor



## CV Carb Adapter

Adapts the HSR-42 Mikuni or CV carb to a 2-bolt manifold.

**41007** 2 Bolt early style



## Manifold Spacer 1971-on

Fits 1971 to present. Includes 2 gaskets.

**2471** Manifold spacer 3/8" (29250-78)

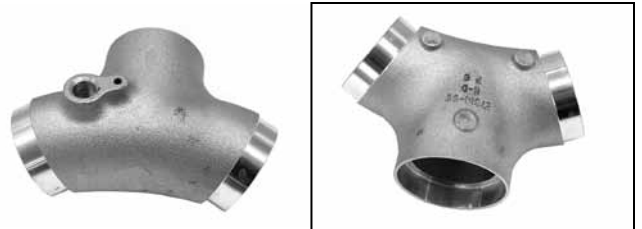

## Stock Intake Manifolds

Are cast alloy as original to fit 1999-on TC88.

**41034** 27613-99

# Air Cleaners



## 7" Nostalgic Style Air Cleaner

Air cleaner with centre screw available with cover to fit Bendix, Tillotson, Keihin and CV carbs. Includes breather tube, backing plate and element. Approximately 3" thick.

PCP	Description
45340	CV 1989-92 BT 1340
45342	CV 1993-on BT 1340
45343	Smooth air cleaner cover only
45344	V-Logo air cleaner cover only
6670	Foam element



## Chrome S&S Air Cleaner Kits for Stock Carbs

170105	Buell, CV 1994-02
170108	BT 1984-89, XL 1986-87 with Butterfly
170100	BT CV 1993-on and XL CV 1991-03
170101	TC 1999-on



## 8" Chrome Nostalgic Air Cleaner

Air cleaner is available for BT 1990-99 as a complete assembly or as a replacement cover only for stock backing plate. Cover features an embossed design and centre screw mounting.

45010	CV	(B) BT 1990-99
-------	----	----------------

## Air Cleaner Covers Only

PCP	Carb	Description
45247	Butterfly	(B) Cover only BT 1984-89
45249	CV	(B) Cover only BT 1990-99

Note: For 1993-on models order breather kit #27170, and for pre-1993 models use bracket #4374



## Colony Polished Chrome Intake Manifold Mounting Kit

9930	BT L1982-89
9931	BT 1990-94, XL 1988-94
9932	BT 1995-on, XL 1995-on



## Eagle Spirit Round Air Cleaner Insert

Fits 1999-on TC88 models.

59156	Chrome
59157	Gold inlay



## Intake Manifold O-Rings & Seals

PCP	Description
14034	L1978-85 Flat seal (27062-78) (10 pk)
14400	As Above, red silicone (10 pk)
14030	1986-on 883-1200 (26995-86A) (5 pk)
14102	1989-on BT-XL (27002-89) (each)

## James Intake Manifold Seal

79510	1986-98 (26995-97-X)
-------	----------------------



# Air Cleaners



## V-Charger Chrome Air Cleaner and Filter

Chrome cleaner includes filter for CV models.

PCP	Style
21796	Smooth
21797	Skull
21798	Flame



## V-Charger Chrome Air Cleaner

Chrome cleaner features air scoop with built-in chrome screen and filter. Kits include brackets and/or breather kits as required.

PCP	Application
59034	CV 2000-on TC88
59035	CV 1993-99 BT
59036	CV 1990-92 BT
59723	S&S 1992-99 BT
59037	Keihin 1984-89 BT
59038	CV 1991-on XL
59039	CV 1988-90 XL
77745	Filter



## Chrome Billet Air Cleaner Cover

PCP	Application
45370	Insert L1999 TC88 (29526-99)
45369	Insert 2000-on (29526-99)
59179	Insert 1984-99 BT Evo w/3 hole, 8" round cleaner



## New Era Air Cleaners Assembly Kit

Kit includes complete chrome air cleaner, mounting bracket, and breather kit.

45353	BT 1993-99
45354	XL 1991-on



# Air Cleaners



## Twin Cam 88 Air Cleaner and Breather Kit

Kit features cast back plate, superior air filter, and includes breather manifold and required hardware. Fits 1999-01 fuel injected touring models. Engine must be recalibrated for proper function of motorcycle.

29412 29441-99A



## Sportster S/E Air Cleaner Kit 1988-03

29437 29066-03



## S/E Stage I EFI Air Cleaner Kits

Use these kits to provide more power to your Twin Cam EFI models. Kits include air cleaner, breather, and all required hardware. Please note recalibration is required for proper installation, and will allow engine to rev to 6200RPM.

### PCP Application

29433 2002-07 EFI Touring models and 2001-07 Softail, 2004-07 EFI Dyna with accessory air cleaner covers (29773-02B)

29432 1999-01 EFI Touring models (29489-99C)



## Stage II High Flow Air Cleaner Kit

Complete breather kit for carbureted BT TC-88 models. Fits 99-05-on Dyna equipped with stock CV carb, 42mm flatside carb or 44mm CV carb and accessory air cleaner covers.

29411 29440-99D



## Screamin Eagle CV Air Cleaner Kit BT 1993-99

29431 29543-99B



## Chrome Air Cleaner Cover for Twin Cam 88

Cover features a concave centre with nostalgic bar and shield emblem. Does not work with Screamin' Eagle high flow filters.

29415 All TC88 engines w/out fuel injection (29550-99)

29416 All TC88 engines with fuel injection (29552-99)

# Air Cleaners

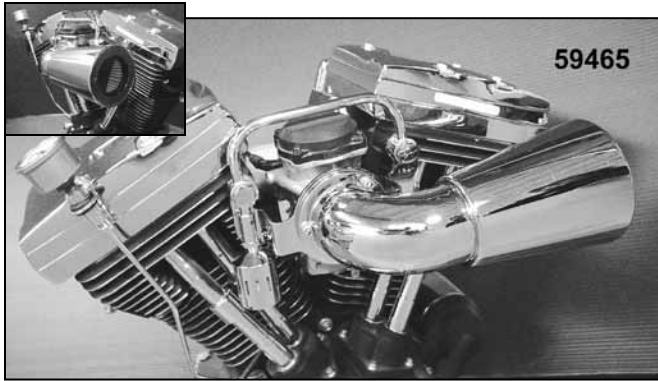

## Air Cleaner Breather and Bracket

Includes billet bracket with breather bolts and tapered filter element with chrome 90 degree intake tube to face forward on CV carbs. To face forward or upward on S&S models, order adaptor plate PCP# 41038 for use with PCP# 59417 spike cleaner.

PCP	Item	Style
59417	Spike	Forward
59465	Funnel	Forward
41006	S&S	Forward adapter
41038	CV	Vertical adapter
59467	Spike filter only	
21698	Funnel filter only	
<b>Air Cleaner Bracket Only</b>		
59720	Spike	
59721	Funnel	



## Panzer Air Cone for S&S E Carbs

Fits S&S E carbs and is fully rotational when used with the Sifton integral breather bracket #21866, sold separately.

PCP	Item	Type
21800	Air cone	Spike
21867	Air cone	Holes
21868	Air cone	Flame
21866	Bracket	
21869	Filter only	



## Adapter Plate

Will rotate #59417 or #59465 air cleaners to a vertical position on CV carbs.

41038



## Adapter Plate

Allows installation of CV air cleaner to S&S Super E carbs and horizontal or vertical mounting of #59417 or #59465 air cleaners.

41006



## CV Air Cleaner Cone Systems

Features cone and integral breather mount bracket for forward mounting.

PCP	Carb	Type
21882	S&S E	With breather tube
21883	CV	Integral



# Air Cleaners



## TC Ram Charger

Available for all Delphi EFI equipped 2001-on FXST, 2002-on FLH/Touring and 2004-on Dyna Glide.

**21769**



## Velo Dish Air Cleaners

Features chrome dish and full flow filter with integral backing plate and hardware. Fits 1992-on FXST carb or FI models and 2002-on FLT FI models.

Cleaner	Size	Filter
59961	6"	77777
59962	8"	77778

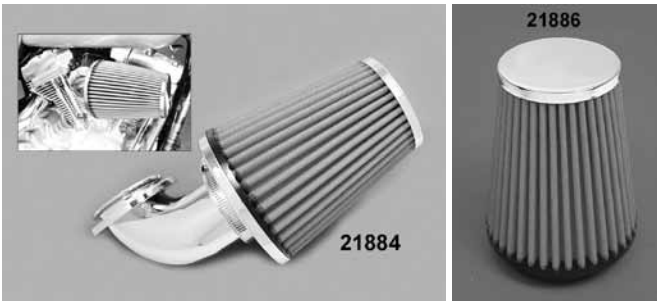

## Cycovator Taper Forward Mount A/C Kit

PCP	Item
21884	CV-EFI
21885	S&S "E"
21886	Filter only

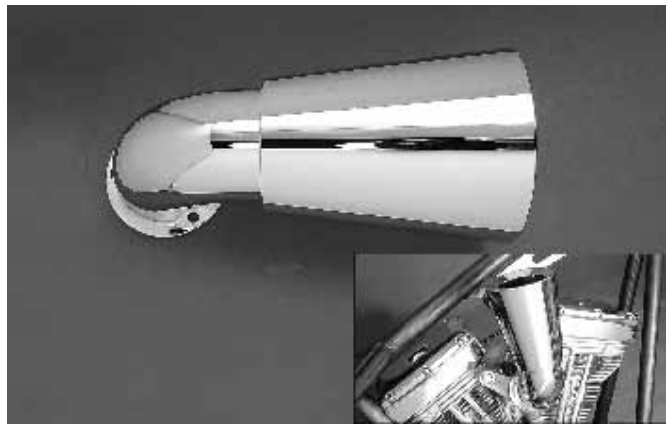

## Air Cleaner Breather Only

Funnel shaped breather includes cone, element and elbow. Fits CV in the horizontal position.

21801	Air funnel
21698	Filter only



## Turbo Funnel

Will mount on CV carb bolt pattern in a forward horizontal position. Order adapter plate #41038 to place in upright vertical position.

**21643**



## Turbo-Fan Velocity Stack

Includes inverted cone filter installed. Turbo fan turns on precision ball bearings up to 10000 RPM.

**21813**

# Air Cleaners



## Chrome Teardrop Big Twin Air Cleaner Kit

Includes die cast backing plate, filter, teardrop chrome cover, breather, canister set and bolts for 1992-on Evo and 1999-on TC88 models.

**59256** CV models



## Cycovator Forward Mount Air Cleaner

Fits 2002-on EFI BT models.

**PCP** **Item**

**21803** Kit with "Taper" style cleaner

**21804** Tapered filter

**21784** 8" Air cleaner

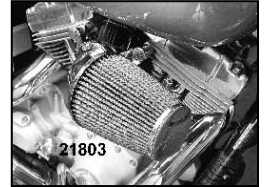

## Chrome Oval Air Cleaner Insert 2000-on TC

**PCP** **Application**  
**45369** Smooth insert



## T/L Swingback Chrome Covers XL 2004

These modern stylish covers feature a curved design that gives the impression of motion. Each cover features an embedded contrasting black label and a lustrous chrome finish.

**PCP** **Application**

**61096** Air cleaner cover (29792-04)



## Chrome Flame Tear Drop Air Cleaner Kits

Kit includes a chrome air cleaner assembly, chrome mount bracket, breather kit with a black hose and a breather unit.

**PCP** **Application**

**59031** 1992-99 BT

**59032** 2000-on TC88

**59033** 1991-on XL

# Air Cleaners



**Velo High Flow Air Cleaner Backing Plate Kit**  
Sifton kit includes chrome one piece alloy backing plate, washable element, accepts 8" round covers with 52" of surface measuring 7" x 2-3/4" deep, stainless steel breather kit with fittings and chrome breather and necessary hardware to mount 1992-on BT models. Cover not included.  
**59407**



**Velco High Flow Air Cleaner Baking Plate Kit By Sifton**  
Includes chrome one piece alloy backing plate, washable element, accepts 8" round covers with 52" of surface measuring 7" x 2-3/4" deep, stainless steel breather kit with fittings and chrome breather filter and necessary hardware to mount 1992-on Big Twins Evo and TC88 models. Covers not included.  
**59409** CV  
**59416** S&S Super "E" models

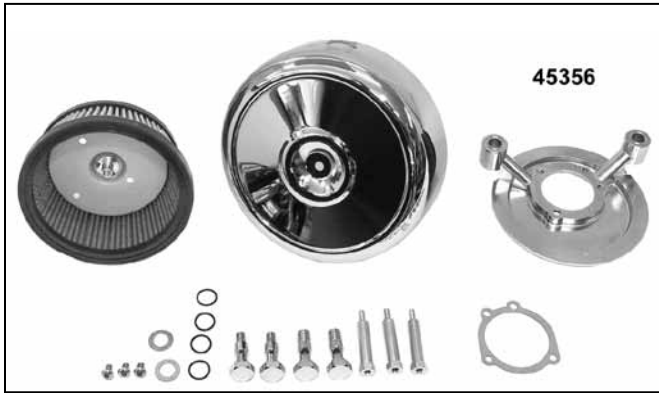

**Velo High Flow Air Cleaner Assembly**  
Includes one piece alloy back plate. Unit includes element, breather kit and all mount hardware for 1992-on BT and TC-88 carburetoed models. Also fits TC-88 EFI 2002-on.

PCP	Application	Description
45356	1992-on carb	With 7" round cover
45357	1992-on carb	With oval cover
77777	Filter only	



**T/L Chrome Billet Air Cleaner Insert 1994-99**  
**63003** 29065-94

# Air Cleaners



## Sifton Air Power

Includes die cast backing plate, filter and breather canisters. Hardware included allows installation on Evo 1992-99 and TC88 models with carburetor. Order cover separately as listed below. Breather bolts also available separately.

- 59221** Air cleaner kit
- 45327** 8" Round cover
- 73584** 1992-99 Bolt set
- 73585** 2000-on Bolt set

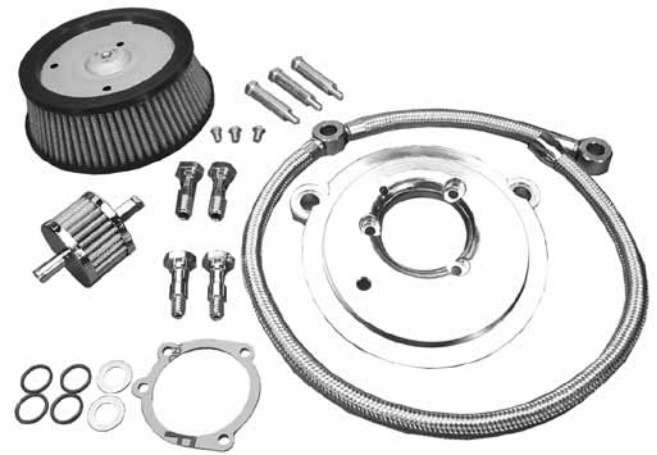

## Velo High Flow Air Cleaner Backing Plate Kit

Kit includes a one piece alloy backing plate, a washable tapered element, stainless steel breather kit with fittings and chrome breather filter and necessary hardware to mount 1992-on BT Evo and TC88 models. Cover not included.

- 59030** Carb model
- 59406** EFI model



## XL Velo Air Cleaner Assembly 1991-on

Bolts on to 1991-on XL models and includes breather bolts.

**59820**



## Early Style Carb Breather Snoots

Features chrome cover without filter. Bendix Keihin and CV have 3 bolt pattern. CV requires the use of #27232 for 2000-on BT or #27224 for 1993-99 BT.

- | PCP          | Application   |
|--------------|---------------|
| <b>59558</b> | Bendix-Keihin |
| <b>59559</b> | CV            |

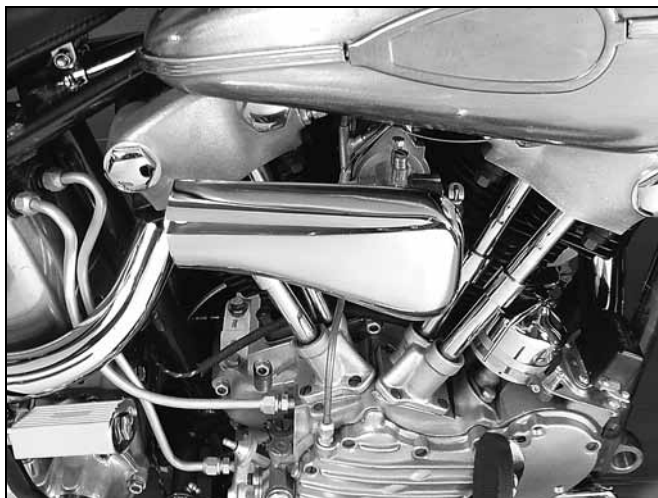

# Air Cleaners



## Skull Air Cleaner

PCP	Application
21737	1999-07 Twin Cam 88 CV and EFI
21861	1993-99 Evo BT

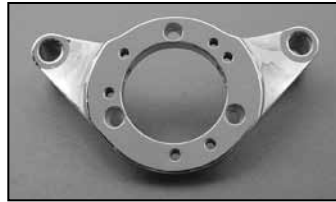

## Chrome Billet Carb Bracket Kit

Features integral breather passage to air intake. Kits include breather bolts and hardware for BT 1993-on Evo and TC-88 models. Use to mount CV pattern velocity stacks or air cleaner.

PCP	Application
59463	CV 1993-on and EFI 2001-on
59464	S&S Super E



## Billet Carb Support

For S&S super E installations. Order banjo bolts and brackets separately for Evo or TC. Bracket is only drilled for S&S style carb. There are no holes for CV air cleaner.  
59478



## Velo Air Cleaner Assembly

Includes billet bushing plate, tapered high flow filter element and all fittings required to fit Evo and Twin Cam 88 1992-on.  
59408

# Air Cleaner



## Air Cleaner Inserts

Round inserts fit the recessed are of round center screw type units.

PCP	Description
45130	7" Chrome (29400-90T)
45230	7" Gold inlay (29401-90T)
45131	8" Evo chrome (29289-89T)



## Billet Air Cleaner Mount Set

Mounts air cleaners with flat backing plates to EV models. Offset billet mounts feature built-in breather passage that feeds inside air cleaner housing. Brackets can be rotated to proper position, then by drilling the back plate. Threaded breather nipples will fasten back plate to brackets.

73655 1991-99



## Diamond Billet Air Cleaner

Fits CV models.  
21799

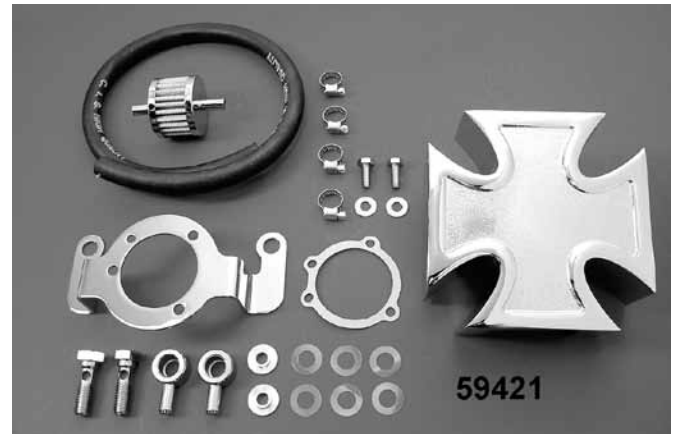

## Chrome Maltese Cross Carb Cover

Includes backing plate without filter. Available as kit or carb cover and backing plate only. Kits include brackets and or breather kits as required to fit stock original carb. Centre portion of cross has a matte chrome finish.

PCP	Application
59421	1993-99 BT

## Air Cleaner Cover only

PCP	Fits
59427	S&S Super E



## Chrome Billet Air Cleaner

Mount kits sold separately.

PCP	Style	Carb
59822	Diamond	CV
21665	Skull	CV
21666	Diamond	S&S
59463	Bracket	Evo and Twin Cam

# Air Cleaner

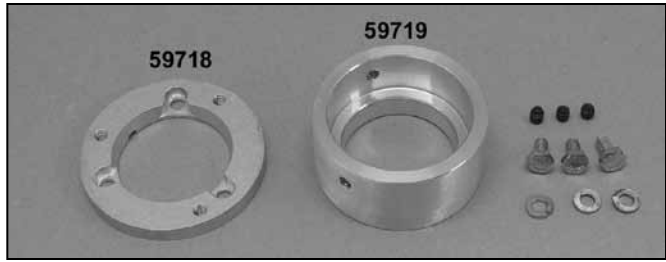
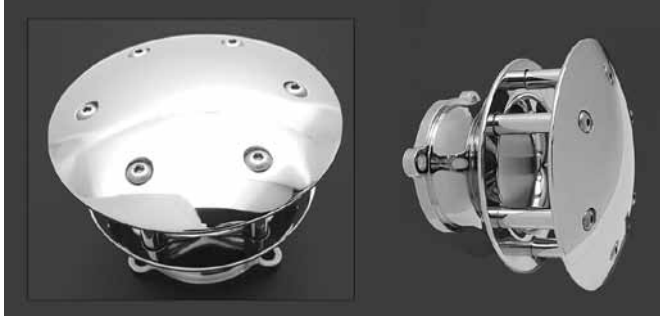
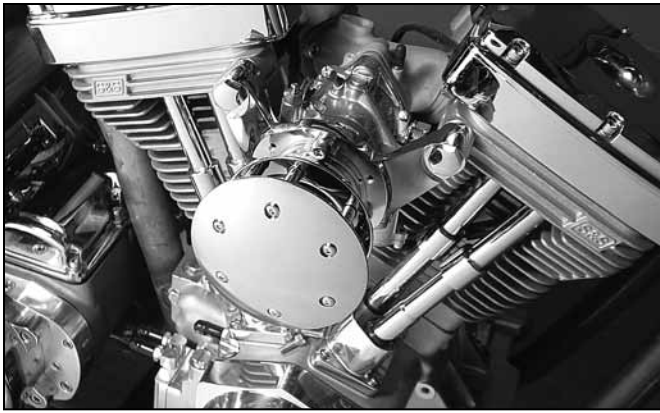

**Mikuni Air Cleaner Adaptor Plate 42 & 45mm**  
Will adapt any CV style, 3-bolt air cleaner to the Mikuni or CV Keihin as noted.

PCP	Application
59717	42mm and 45mm Mikuni
41006	CV to S&S E and G
59718	38mm CV to Keihin
59719	38mm Mikuni



## Velo-dome Velocity Stack

Domed velocity stack fits Super E models.

PCP	Item
21757	Stack with cover
59478	Bracket kit with integral breather passages

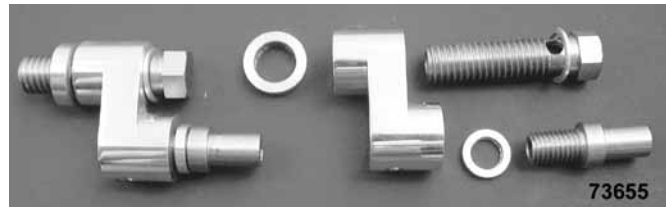

## Billet Air Cleaner Mount Set

Will mount air cleaners with flat backing plates to EV and TC-88 models. Offset billet mounts feature built-in breather passage that feeds inside air cleaner housing. Brackets can be rotated to proper position, then by drilling the back plate. Threaded breather nipples will fasten back plate to brackets.

PCP	Application
73655	1991-99 Evo
73656	2000-on TC-88



## Billet Velocity Stack-S&S Super E

Fits #59464 bracket. Stack includes inverted cone filter element.

PCP	Item
21790	Kit
59547	Stack
59464	Bracket
73617	Replacement filter



## Billet Scoop Air Cleaner

Includes filter and mount brackets. Fits 1991-on BT with carburetor.

PCP	Style
59725	Smooth

# Air Cleaners



## Tear Drop Air Cleaner Assembly

Tear drop style die cast air cleaner assembly. Fits all the Bolt Carbs, Keihin, (not CV), Tillotson, & S&S units (not E or G).  
**1229** Air cleaner, complete (29205-87T)



## 8" EVO Type Air Cleaners

Includes chrome cover, foam element and backing plate. Order brackets separately.

PCP	Description
45325	Keihin
45326	CV 1989-on
45327	Cover only
6670	Foam element



## Chrome Round Cover for CV

Fits 1993-on FXST.  
**21789**



## Ribbed Teardrop Air Cleaner

Chromed aluminum cover features diecast backing plate and built-in venturi for increased air flow.

PCP	Description
45144	Fits CV carbs XL 1988-on, BT 1990-on EVO



**27224**

## Crankcase Breather and Bracket Kit

Fits CV carbs to allow use of aftermarket air cleaners on models with cylinder head/crankcase breather systems. Air cleaner must be ordered separately.

PCP	Description
27223	XL 1991-03
27224	BT 1993-99
27232	BT TC88 2000-on
77027	Filter for above

## S&S Aircleaner Cover

Screws, chrome plated.  
**4736** Set of 3



**16253**



**16534**

## Evo Breather Kit

For use with custom air cleaner or carb on BT 1993-on and XL 1991-on. Accepts 3/8" hose.

16253	4 pc kit
16534	Bolts only Evo 1992-99
16538	Bolts only TC88 1999-on

# Air Cleaners



## Chrome Air Cleaner Brackets, for Evolution

Mounts to boss on engine heads to support custom air cleaners.

PCP	Model	Years
27022	1340cc (inlet 2")	1984-89 (mount holes 6" c/c)
27024	1340cc (inlet 2-1/4")	1990-91 CV (as above)
59720		1984-99 with choke bracket
59721		1993-on (for use w/breather kit)
27023	883-1100-1200XL	1985-87 (mount holes 5" c/c)
27025	883-1100-1200XL	1988-90 CV (as above)

Note: These support brackets will not work with #45336 series round air cleaners or #6591 air cleaners

## Custom Air Cleaner Breather Kit BT 1992

Necessary when using custom air cleaners or carbs.

27082 29304-92



## 1993-on EVO BT Breather Kit

For custom air cleaners to motors with the internal breathing system.

PCP	Description
27172	BT 1993-on w/round cleaner (not FXD) (29310-93)
27171	XL 1991-03 w/teardrop air cleaner (29281-91T)
27170	BT 1993-on w/teardrop (not FXD) (29283-92T)
16534	Banjo bolts only Evo 1992-99 (pair)
16538	Banjo bolts only TC88 99-on (pair)

## Chrome Air Cleaner Support Brackets

For installing custom round or teardrop air cleaners on BT 1984-92 and XL 1985-90.

4374 29208-87T



## Air Cleaner Mount Gaskets (10 pack)

James	PCP	Description
	25096	1977-89 (29058-77)
79190	25186	1988-on CV type (29059-88)
79519	-	1995-on Injector type (5 pk)
79546	-	1995-on Carb (29062-95B)



## Extended Breather Bolts

Allows the mounting of air cleaner to breather bolt stand.

PCP	Application
73657	TC-88
73658	Evo, XL

## Carb Vent Fitting

1/8" Chrome, steel nipple for air cleaner backing plates. Sold in 5 packs.

PCP	Hose	Angle
10502	5/16"	90 degree

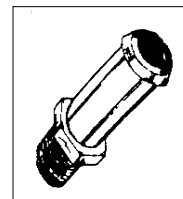

# Air Cleaners

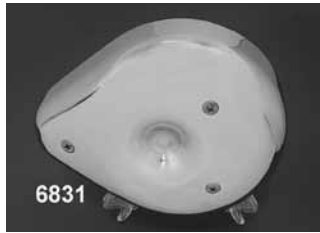

## 883-1200 & BT CV 1990-on Air Cleaner

Chrome die cast tear drop design with backing plate to fit the constant velocity carbs on 1988-on XL and BT 1990-on. Includes element.

- 6831** Smooth tear drop
- 6832** "Live To Ride" chromed (29286-88T)
- 45240** "Live To Ride" gold inlay



## "Live To Ride" Air Cleaner Assembly

This high-quality air cleaner assembly features a chrome plated die-cast aluminum cover and a built-in venturi which delivers improved performance. Includes the backing plate, screws and a foam filter element.

- 6594** Fits S&S carbs (not "E"s) as well as Tillotson, Bendix (Zenith) and Keihin (except CV) (29204-87T)
- 45239** As above with gold overlay
- 6670** UniFilter foam air filter element
- 77710** Accel foam element



## Bracket for CV to Custom Air Cleaner

- |              |                      |
|--------------|----------------------|
| <b>PCP</b>   | <b>Fit</b>           |
| <b>27171</b> | 1991-03 XL           |
| <b>27170</b> | 1993-on BT (not FXD) |
| <b>4374</b>  | 1985-90 BT           |



## Replacement Parts for Tear Drop Air Cleaners

- | PCP          | Description                 |
|--------------|-----------------------------|
| <b>45277</b> | Polished cover              |
| <b>45279</b> | Chrome cover                |
| <b>45233</b> | Bendix-Keihin backing plate |
| <b>45234</b> | CV backing plate            |
| <b>4736</b>  | Chrome screw set (3 pack)   |
| <b>6670</b>  | Uni-filter element          |



## Flame Tear Drop Air Cleaner

Comes complete with chrome cover, foam element and backing plate. Brackets sold separately. XL 1991-99 and BT 1993-on bracket kits include breather line.

- 45190** Bendix-Keihin
- 45191** CV



## Eagle Spirit Collection

Heavy die-cast chrome plated pieces, emblazoned with an eagle design. Air cleaners are die casted with 3 bolt mounting and venturi style backing plates for Keihin and Bendix use. Points cover fits 1970-on FX-FL models with horizontal screws.

- 6590** New Era air cleaner (not CV carbs)
- 6591** Centre screw cleaner (not CV carbs)
- 45112** Points cover
- 6592** Derby cover, 3 Bolt

# Air Cleaner

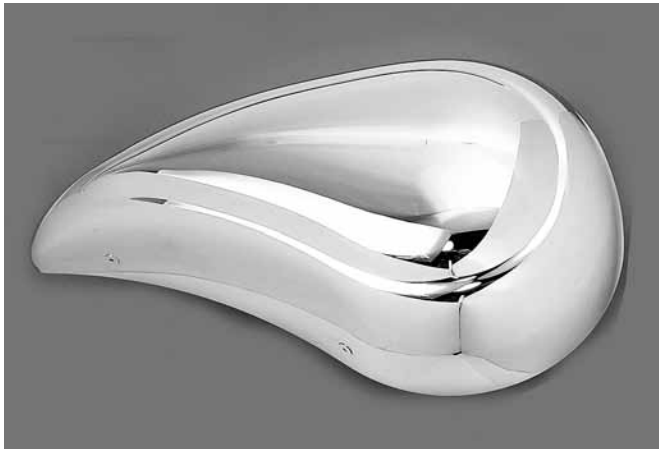

## Chrome Teardrop Air Cleaner Assembly

Fits S&S E models. Filter and back plate included.

**59947** Assembly 1992-on Evo, Twin Cam

**77777** Filter only

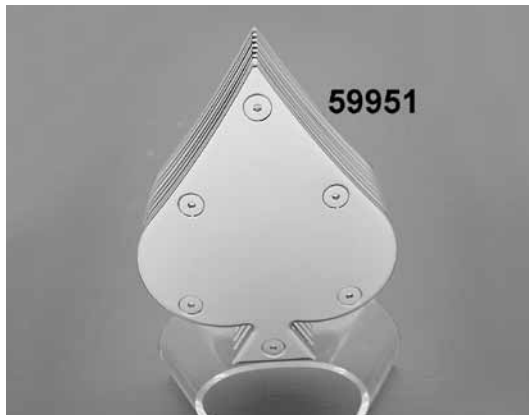

## Spade Chrome Billet Air Cleaner Assembly

Fits CV carbs. Bracket kit not included.

**59951**



**77101**

**4634**

## Crankcase Breather Assembly

Mount your breather in plain view instead of hiding it behind your engine or transmission case. Comes complete with a one-piece filter molded to a light weight chrome end cap, a chrome zinc die-cast mounting base with 5/16" inlet and a hose clamp. The hose clamp holds the filter to the base when the vent hose is installed.

**77101** Complete assembly

**4634** Replacement filter ONLY (no chrome)  
2" diameter x 1/2" height



## Chrome Flow Swept Air Cleaner Assembly

Fits 1993-on EV and TC models. Bracket kit sold separately.

**59948** Assembly

**59949** Bracket kit

**77777** Filter only

# Carb Breathers



## Sifton Dual Breather Kit

Includes 2 canisters, banjo tubes and bolts for Evo and TC88 applications.

**59158**

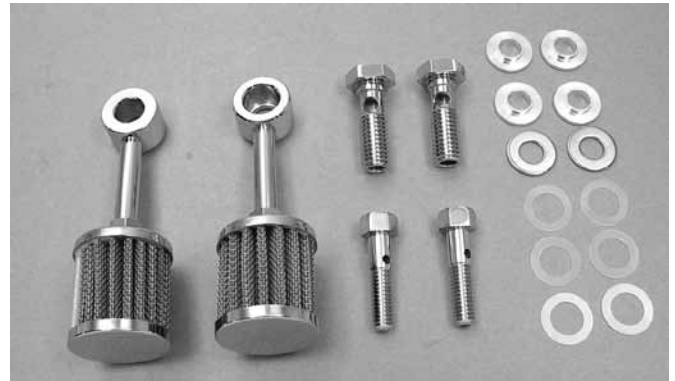

## Sifton Dual Breather Kit

Kit includes 2 breathers with chrome ends and banjo tubes with hardware for Evo and TC88.

**59228**



## Sifton Mini Breather Bolt Kit

Unique chrome breather cups have built in mount bolt for 1992-99 BT and XL models.

**44080**



## Chrome Billet Canister Set

Includes bolts for Evo and TC88 applications.

**59438**

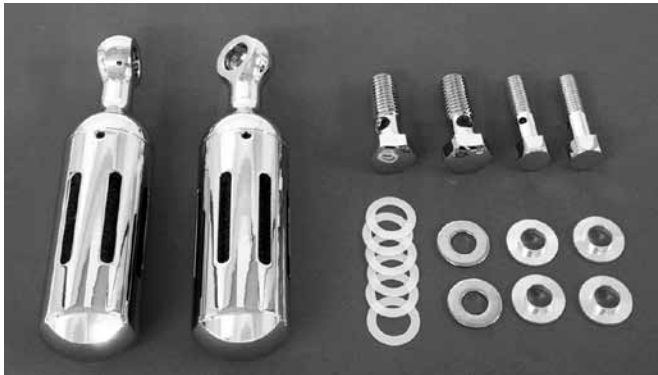

## Sifton Chrome Dual Canister Breather Kit

Fits Evo and Twin Cam models.

**59244**



**16534**

## BT Breather Bolts 1992-on

PCP	Application	Type
<b>16534</b>	1992-on Evo	Hex
<b>73610</b>	1999-on TC	Hex
<b>16538</b>	1999-on TC	Nipple
<b>73611</b>	1992-on Evo	NPT



**73610**

# Carb Breathers



## Sifton Vent Cannister

Includes line and clamps.

**59160**



## Sifton Dual Vent Kit

Includes 2 vent cannisters, fittings and banjo bolts for Evo and TC88 models.

**59159**



## Chrome Billet Crankcase Breather

Features 1/8" NPT fittings.

**77106**



**73501**

**73502**

## Breather Bolt and Banjo Kit BT

Includes bolts for 1993-02, XL 1991-02 applications and 2 banjo bolts to accept 5/16" hose.

**PCP Description**

- 73501** Without tee
- 73502** With tee
- 73503** Evo nylon washers
- 73504** TC88 nylon washers

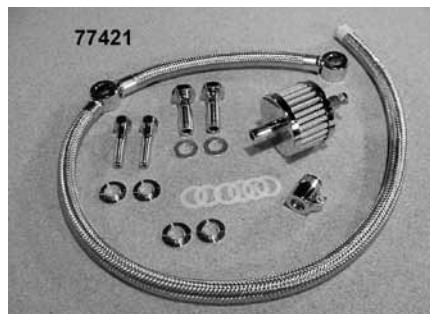

## Sifton Braided Hose Crankcase Breather Kit

Kit features a 3/8' I.D. braided stainless steel hose, breather filter with mounting stud, and hardware. Air cleaner and carb support bracket must be purchased separately. Fits 1993-2001 BT custom applications only.

**PCP Description**

- 77421** Kit
- 77105** Breather
- 73500** Bolt kit

## Sifton Breather Canister

Features enclosed breather filter and tube for attaching to breather cross over lines, which is held in place by set screws. Bottom cover is removable for cleaning.

**PCP Description**

- 59195** Canister
- 59196** Breather tube kit
- 59197** Tube only



**21767**

## Yost Pro Mod Breather Kits

Designed to be modular, this kit allows for a custom look with an extra 2 ponies. Kits can be used with an air filter and stock cover, or without an air filter by using the screen provided. Machined from solid 6061 T6 billet aluminum with an unique internal breather design (no more hoses). Includes installation hardware.

**PCP Item**

- 21767** Kit 1999-on TC, 2002-on Delphi FI
- 21768** Kit 1993-99 Evo BT

# Cable Clamps



## 2 Piece Chrome Dual Throttle Cable Separator

PCP	Holes	Handler Bar Size
73508	2	1"
73509	1	1"
73510	2	1-1/4"
73511	2	1"

## 2 Piece Chrome Cable Clamps.

Secures cables or wires to frame and forks. Sold each.

PCP	Size	# Holes	Type
27525	1"	1	Clutch
27526	1"	2	Throttle
27511	1-1/8"	1	
27512	1-1/4"	1	Throttle
73748	1-1/4"	2	Throttle
73749	1-1/4"	1	Clutch
27513	35mm	1	Clutch
27515	39mm	1	Speedo
73667	41mm	1	Speedo
73750	49mm	1	Clutch



## Chrome Cable Clamps

Unique two piece design allows easy installation. Swivel head design allows more natural cable routing without excessive bending. Rubber sleeves protect painted surfaces and cable housing. 1" clamps fit handlebars and aftermarket frames.

PCP	Size	Holes	Type
44119	1-1/4" - 1-1/2"	Single	Throttle/clutch
44120	1-1/4" - 1-1/2"	Dual	Throttle/clutch
44121	1" - 1-1/8"	Single	Throttle/clutch
44122	1" - 1-1/8"	Dual	Throttle/clutch
44123	7mm - 9mm	Single	Cable holder
44124	7mm - 9mm	Dual	Cable holder



## Chrome Billet Cable Clamps-Sold Each.

PCP	Size	Application
73670	1"	Throttle cable, single
73671	1"	Throttle cable, dual
73672	1"	Clutch cable
73673	1-1/8"	Clutch cable
73674	41mm	Clutch cable
73692	39mm	Clutch cable
73675		Speedo cable to fender



## 41mm Push On Fork Tube Clamps

Use to secure speedo cables and brake lines. Sold Each.

PCP	Style
44086	Smooth
44087	Groove

# Throttle Cables



## Barnett Throttle Cables

All Barnett throttle cables are made with black PVC coated stock diameter nylon lined casing with 3/64" extra flexible (7 x 7 strand) inner cable for extra long life. All cable fittings and elbows are bright nickle finish.

### Barnett Misc. Carb Cables

Part	Size	Description
2234		For early type Mikuni carb conversion 38-44mm , universal, not for HS40 and newer
47000	41"	Throttle cable Mikuni HS 40 kits thru 1995 130 degree elbow
47002	41"	Idle cable, as above
47005	41"	Throttle cable Mikuni HS 40 kits 1996-on 90 degree elbow
47006	41"	Idle cable, as above
47007	36"	Throttle cable Mikuni HS-42/45 1981-95 130 degree elbow
47008	37"	Idle cable, as above
47009	36"	Throttle cable Mikuni HS-42/45 1996-on 90 degree elbow
47010	37"	Idle cable, as above
47011	38"	Throttle cable S&S Super E,G 1981-95 130 degree elbows
47832		S.S. as above
47012	38"	Idle cable, as above
47833		S.S. as above
47013	38"	Throttle cable S&S Super E,G 1996-on w/90 degree elbow
47834		S.S. as above
47014	38"	Idle cable, as above
47835		S.S. as above
7424	35"	Throttle cable S&S (not super E,G), SU, Bendix 1981-95, 130 degree elbow
7426	35"	Idle cable, as above
7425	41"	Throttle cable, as above
7427	41"	Idle cable, as above

## Barnett Throttle Cables For Mikuni HS40 Kits Mikuni Thru 44mm (Not HS 40/42/45)

- 47000 Throttle cable (pull) 41" 130 degree 1982-95
- 47001 Throttle cable +6" (pull) 130 degree 1982-95 (47" outer)
- 47002 Idle cable (push) 41" 130 degree to 1982-95
- 47003 Idle cable +6" (push) (47" outer)
- 47004 Adapts 1981-95 stock throttles to Mikuni carbs thru 44mm (not HS 40/42/45)

## Chrome Throttle Clamps

Clamps feature smooth design, upper and lower pieces with screws for single or dual cable applications.

PCP	Application
73506	Single
73507	Dual



## Chrome Throttle Housing

Custom design for single cable operation.

73663



## Chrome Cable Wrap 60" Long

Classic 50's style dresser trim item.

45196 Small diameter 3/16"



## FLT 1984-89 Carb Cables Imported

- 47420 Throttle (56327-81B)
- 47421 Idle (56328-81B)

## XL Throttle or Idle Cable Assemblies

- | Black | Description            |
|-------|------------------------|
| 5701  | 1986-87 Stock throttle |
| 5702  | As above stock idle    |

# Throttle Cables

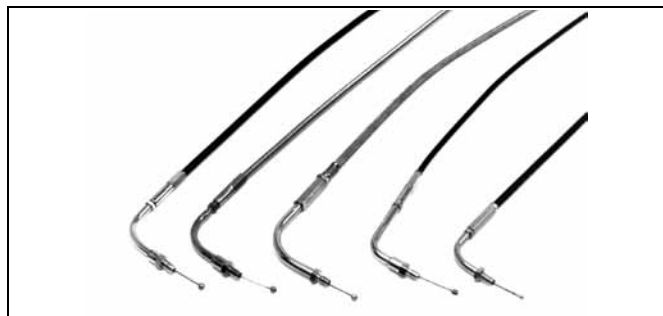

## Big Twin Throttle or Idle Cable Assemblies.

Available in black vinyl or braided stainless steel (not clear coated) with correct end fitting for each application. Also available in overstock length, as noted.

Stainless	Black	Description (Imported)
5705	2237	1981-89 FX, FLH, FXST, FLST Stock throttle cable
5715	-	As above +8"
-	47426	As above +12"
5704	2238	As above stock idle
-	47427	As above +12"
-	3651	1983-87 FXRT, FXLR, FXRSE Stock throttle cable
-	3655	As above stock idle cable
47550	-	1990-95 FXLR, FXRS, FXRT, FLST, FXR, FXST, FXSTC, FLST, FLSTC +8" idle

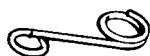

## Control Cable Guide Hook

Replaces OEM 45092-66. Stock on 1966-89 FL's but has many universal applications.  
**3980** Control hooks (5 pk)

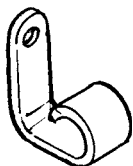

## Cable Routing "L" Bracket

Chrome bracket used for 1/2" O.D., on brake, clutch cables and hoses. 1/4" mounting hole.

**16200** Sold each

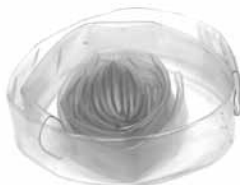

## Heat Shrink Tubing for Braided Cables

Use clear heat shrink tubing on all braided stainless steel cables to prevent scratching of chromed or painted surfaces. Kit contains 4-16" long heat shrink tubes to cover 2 throttle cables, 1 clutch and 1 speedo cable.

PCP	Application
28713	Cable sleeve kit
28714	3/8" x 10' roll
28715	1/2" x 10' roll
28716	3/4" x 10' roll



## M&M Clear Coated Stainless Braided Cables

Cables for throttle and idle applications.

PCP	Size	Application
59869	42"	1996-on S&S
21847	44"	1996-on S&S
59605	50"	1996-on S&S
59603	38"	1982-95 S&S
59604	50"	1982-95 S&S
59600	Stock	1996-on FXST, FLST, FXD
59870	+8"	1996-on FXST, FLST, FXD
59601	Stock	1990-95 FXST, FLST, FXR
21848	+8"	1990-95 FXST, FLST, FXR
59602	Stock	1981-89 FX, FLST, FLH
21834	Stock	1998-01 FLTR1 1996-01 FLHTCUI
21835	Stock	2002-on FLHRC, FLHR/I

## Inner Throttle Sleeve

Custom design allows pull action or throttle cable for use with billet grips.

**59730**



1. Cut 2-3/8" off end of handlebar. Remove end of throttle handle that would attach to throttle cables.
2. Mark handlebar for inner throttle sleeve. Drill a hole for the set screw that will hold throttle on the handlebar.
3. Remove set screw from the outer sleeve of spiral. Slide grip on and mark the end of grip on the handlebar. Measure from this mark back to set screw in outer sleeve. This measurement will be used to mark and drill the throttle grip. Once drilled, install grip. Use a small amount of Loctite on set screw for final installation.



## Radii Roller Bearing Throttle Sleeve

Features precision ground bearing for smooth operation by reducing drag at end point. Requires handlebar modification. Accepts stock type nylon throttle tube or billet grips for either single or dual cable application.

**59731**

# Barnett Cables

Barnett's smooth working, long lasting cables are virtually indestructible and are made from the finest components available. Casings are constructed from hard drawn spring wire and all fittings, ferrules and adjusters are machined in house from brass, aluminum and stainless steel to stringent specifications. All Barnett throttle cables are made with black PVC coated stock diameter nylon lined casings with 3/64" extra (7x7 strand) inner cable for extra long life. All cable fittings and elbows have a bright nickel finish. **All stainless cables have an anti-abrasive clear coat to protect paint and polished metal.**

## THROTTLE CABLES

OEM	Black Vinyl		Stainless Steel	
	STD	+6"	STD	+8"
56306-88	47226	47227		
56306-90	47230	47231		
56306-96	47254			
56308-86	47208	47209		
56308-88	47212	47213	47800	47801
56308-96	47240		47804	47805
56313-76	47202	47203 +8"		
56314-78	47200			
56320-77	47202			
56324-81C	47204	47205 +8"	47808	47809
56327-81B	47216		47812	47813
56327-90	47220		47824	47825
56327-96	47262		47828	47829
56336-83	47224			
56343-88	47238			
56343-90	47234	47235 +8"	47816	47817
56343-96	47249	47250 +8"	47820	47821
56357-02	47304			
56375-96	47262		47828	47829
56376-94	47220			
56379-96	47246			
56400-96	47258			
56357-96	47248			

## IDLE CABLES

OEM	Black Vinyl		Stainless Steel	
	STD	+6"	STD	+8
56305-88	47228	47229		
56305-90	47232	47233		
56305-96	47256			
56309-86	47210	47211		
56309-88	47214	47215	47802	47803
56309-96	47242		47806	47807
56323-81C	47206	47207 +8"	47810	47811
56328-81B	47218		47814	47815
56328-90	47222		47826	47827
56328-96	47264		47830	47831
56337-83	47225			
56342-88	47239			
56342-90	47236	47237 +8"	47818	47819
56342-96	47251	47252 +8"	47822	47823
56358-96	47247			
56362-02	47306			
56375-96	47264		47830	47831
56401-96	47260			

## THROTTLE CABLES

Sportster Models	Black Vinyl		Stainless Steel	
	STD	+6"	STD	+8"
XLH 883 1986-87	47208	47209		
XLH 883 1988-95	47212	47213	47800	47801
XLH 883 1996-99	47240	47241	47804	47805
XLH 883 Deluxe 1987	47208	47209		
XLH 883 Deluxe 1988-95	47212	47213	47800	47801
XLH 883 Hugger L1987	47208	47209		
XLH 883 Hugger 1988-95	47212	47213	47800	47801
XLH 883 Hugger 1996-99	47240	47241	47804	47805
XLH 883C Hugger 2000-01	47270			
XLH 883R 2002-03	47240		47804	47805
XLH 1100 1986-87	47208	47209		
XLH 1200 1988-95	47212	47213	47800	47801
XLH 1200 1996-99	47240	47241	47804	47805
XLH 1200 C 1996-99	47240	47241	47804	47805
XLH 1200 S 1996-03	47258			
XLH 1200C 2000-01	47270			
XLH 1200C 2002-03	47258			

## IDLE CABLES

Sportster Models	Black Vinyl		Stainless Steel	
	STD	+6	STD	+8"
XLH 883 1986-87	47210	47211		
XLH 883 1988-95	47214	47215	47802	47803
XLH 883 1996-99	47242	47243	47806	47807
XLH 883 Deluxe 1987	47210	47211		
XLH 883 Deluxe 1988-95	47214	47215	47802	47803
XLH 883 Hugger L1987	47210	47211		
XLH 883 Hugger 1988-95	47214	47215	47802	47803
XLH 883 Hugger 1996-99	47242	47243	47806	47807
XLH 883C Hugger 2000-01	47272			
XLH 883R 2002-03	47242	47243	47806	47807
XLH 1100 1986-87	47210	47211		
XLH 1200 1988-95	47214	47215	47802	47803
XLH 1200 1996-99	47242	47243	47806	47807
XLH 1200 C 1996-99	47242	47243	47806	47807
XLH 1200 S 1996-03	47260			
XLH 1200C 2000-01	47272			
XLH 1200C 2002-03	47260			

## For Big Twin Models

FLHR 1994-95	47220			47222			
FLHR 1996-01	47262		47828	47829	47264		47830 47831
FLHR 2002-04	47304				47306	47321*	
FLHR-I 1996-01	47246				47247	47323*	
FLHR-I 2002-04	47304				47306	47324*	
FLHRC-1 1998-99	47248				47247	47323*	
FLHRC-1 2000-01	47246				47247	47323*	
FLHRC-1 2002-04	47304				47306	47324*	
FLHS L1987-89	47216		47812	47813	47218		47814 47815
FLHS 1990-95	47220		47824	47825	47222		47826 47827

\*Cruise cable (extra length)

# Barnett Cables

	THROTTLE CABLES				IDLE CABLES			
	Black Vinyl		Stainless Steel		Black Vinyl		Stainless Steel	
	STD	+8"	STD	+8"	STD	+8	STD	+8"
FLHT 1984-89	47216		47812	47813	47218		47814	47815
FLHT 1990-95	47220				47222			
FLHT 1996-01	47262	47263	47828	47829	47264	47265	47830	47831
FLHT 2002	47304				47306			
FLHT 2003	47314							
FLHTC 1983	47204	47205	47808	47809	47206	47207	47810	47811
FLHTC 1984-89	47216		47812	47813	47218		47814	47815
FLHTC 1990-95	47220		47824	47825	47222		47826	47827
FLHTC 1996-01	47262	47263	47828	47829	47264	47265	47830	47831
FLHTC 2002	47304				47306			
FLHTC 2003	47314							
FLHTC-1 1996-01	47248		N/A					
FLHTC-1 2002-06	47304				47306			
FLST 1986-89	47204	47205	47808	47809	47206	47207	47810	47811
FLST 1990	47234	47235	47816	47817	47236	47237	47818	47819
FLSTC L1987-89	47204	47205	47808	47809	47206	47207	47810	47811
FLSTC 1990-95	47234	47235	47816	47817	47236	47237	47818	47819
FLSTC Heritage, FLSTC-I								
Heritage F/I 2001-03	47310				47312			
FLSTF 1990-95	47234	47235	47816	47817	47236	47237	47818	47819
FLSTF 1996-99	47249	47250	47820	47821	47251	47252	47822	47823
FLSTN 1993-95	47234	47235	47816	47817	47236	47237	47818	47819
FLSTN,C,F 1996-99	47249	47250	47820	47821	47251	47252	47822	47823
FLSTS 1998-99	47254				47256			
FLSTS 2000	47249				47251			
FLSTS, FLSTS-I 2001-03	47310				47312			
FLT 1984-86	47216		47812	47813	47218		47814	47815
FLTC 1984-89,Ultra 1989	47216		47812	47813	47218		47814	47815
FLTC 1990-95, Ultra	47220		47824	47825	47222	47322*	47826	47827
FLTCU-I 1996-2000	47248				47247			
FLTR 1998-2001	47262				47264			
FLTR 2002	47314				47316	47325*		
FLTR-I 1998-99	47246				47247			
FLTR-I 2000-01	47248				47247			
FLTR-I 2002-03	47304				47306			

\*Cruise cable (extra length)



## Throttle Clamp Sets

Chrome die-cast clamp sets include the upper and lower clamp with screws.

**PCP Type**  
**4785** Dual cable clamp set



## Radii Billet Throttle

Accepts single 1982-95 throttle cable.  
**73662**



## Chrome Dual Billet Throttle Housing

For use with idle and throttle cable.  
**73713**

# Barnett Cables

	THROTTLE CABLES				IDLE CABLES			
	Black Vinyl STD	+8"	Stainless Steel STD	+8"	Black Vinyl STD	+8	Stainless Steel STD	+8"
FXD 1996-03	47249				47251			
FXDB, FXD, D/Glide 1991-95	47234	47235	47816	47817	47236	47237	47818	47819
FXDL, FXDWG 1993-95	47234	47235	47816	47817	47236	47237	47818	47819
FXDL 1996-03	47249				47251			
FXDS-CONV, FXDWG 1996-03	47249				47251			
FXDWG w/OEM stainless			47820				47822	
FXDX 2000-03	47249				47251			
FXDXT 2002-03	47249				47251			
FXEF 1981-85	47204	47205	47808	47809	47206	47207	47810	47811
FXLR 1987	47224				47225			
FXLR L/Rider Custom 1988-89	47238				47239			
FXLR L/Rider Custom 1990-95	47234	47235	47816	47817	47236	47237	47818	47819
FXR 1982-89	47204	47205	47808	47809	47206	47207	47810	47811
FXR Superglide 1990-94	47234	47235	47816	47817	47236	47237	47818	47819
FXRC L1985-L87	47204	47205	47808	47809	47206	47207	47810	47811
FXRD 1986	47224				47225			
FXRDG L1984, FXRS 1982-89	47204	47205	47808	47809	47206	47207	47810	47811
FXRS 1990-95	47234	47235	47816	47817	47236	47237	47818	47819
FXRS Convertible L1989	47204	47205	47808	47809	47206	47207	47810	47811
FXRS Convertible 1990-95	47234	47235	47816	47817	47236	47237	47818	47819
FXRS Sport Edition L1985-86	47204	47205	47808	47809	47206	47207	47810	47811
FXRS Sport Edition 1987-89	47224				47225			
FXRS Sport Edition 1990-93	47234	47235	47816	47817	47236	47237	47818	47819
FXRT 1983-89	47224				47225			
FXRT 1990-92	47234	47235	47816	47817	47236	47237	47818	47819
FXSB 1983-85	47204	47205	47808	47809	47206	47207	47810	47811
FXST 1984-89	47204	47205	47808	47809	47206	47207	47810	47811
FXST 1990	47234	47235	47816	47817	47236	47237	47818	47819
FXST 1996-2000	47249				47251			
FXST std, FXST-I std F/I 2001-03	47310				47312			
FXSTB 1999	47326				47328			
FXSTB, FXSTB-I Nite Train 00-03	47326				47328			
FXSTC 1986-89	47204	47205	47808	47809	47206	47207	47810	47811
FXSTC 1990-95	47234	47235	47816	47817	47236	47237	47818	47819
FXSTC 1996-99	47249	47250	47820	47821	47251	47252	47822	47823
FXSTD 2000	47249				47251			
FXSTD, FXSTD-I Duece 2001	47310				47312			
FXSTD Duece 2002-03	47310				47312			
FXSTD-I Duece F/I 2002-03	47310				47312			
FXSTS L1988-89	47226	47227 +6"			47228	47229 +6"		
FXSTS 1990-95	47230	47231 +6"			47232	47233 +6"		
FXSTS 1996-99	47254				47256			
FXSTS 2000-03	47254				47256			
FXSTS-I, Springer F/I	47254				47256			
FXSTSB 1995	47234	47235	47816	47817	47236	47237	47818	47819
FXSTSB 1996-97	47249	47250	47820	47820	47251	47252	47822	47823
FXWG 1981-86	47204	47205	47808	47809	47206	47207	47810	47811
VRSCA, V-Rod 2002-03	47318				47320			



## Dual 1981-95 Push-Pull Kit

**PCP Application**  
**59740** 1981-90 Kit w/Barnett cables  
**59741** 1991-95 Kit w/Barnett cables

## 38" Throttle and Cable Kit

Kit includes grips, throttle idle and Barnett throttle cable with ends attached for S&S Super E and G carbs.  
**59739**